

TRANSVERSE TORQUE



November - December 2006 Issue No. 163



The magazine of the Ford Y & C Model Register

REGISTER OFFICERS

Chairman	Peter Ketchell	2 Manor Road, Westminster Park, Chester CH4 7QW Tel: 01244 676856 e.mail: peter.ketchell@lineone.net
Vice-Chairman	Bob Wilkinson	Rose House, 9 Brambleside, Thrapston, Northants NN14 4PY Tel: 01832 734463 e.mail: bob@bwilkinson49.fsnet.co.uk
Secretary	Bob Wilkinson	Rose House, 9 Brambleside, Thrapston, Northants NN14 4PY Tel: 01832 734463 e.mail: bob@bwilkinson49.fsnet.co.uk
Treasurer	Bruce Allan	37 Meadow Park, Cabus, Garstang, Lancs PR3 1TA e.mail: bruceallan@telco4u.net
Membership Officer	Godfrey Dingley-Jones	75 Monteagle Drive, Kingswinford, West Midlands DY6 7RY Tel: 01384 350465 e.mail: dingley-jones@blueyonder.co.uk
Spares Secretary	Jim Sharpe	23 Rous Chase, Galleywood, Chelmsford, Essex CM2 8QF Tel: 01245 351546 e.mail: jajm.sharpe@virgin.net
Spares Administrator	Colin Rowe	15 Orchard Close, Towcester, Northants, NN12 6BP Tel: 07944 825 045 Fax: 01327 359772 e.mail: ColinJRowe15@aol.com
Regalia Officer	John Argent	35 Brookmans Ave., Brookmans Park, Hatfield, Herts AL9 7QH Tel: 01707 662049 e.mail: john@argyfsnet.co.uk
Editor & Archivist	Sam Roberts	16 Croye Close, Andover, Hants SP10 3AF. Tel: 01264 365662 e.mail: sam@samroberts.plus.com
Technical Advisor	Geoff Dee	27 Ladycroft, Cubbington, Leamington Spa, Warwicks CV32 7NH Tel: 01926 334780 e.mail: GJDee@hotmail.com

THE FORD Y & C MODEL REGISTER web site is at www.fordyandcmodelregister.co.uk
Annual Subscriptions:- UK £25.00 (\$/order preferred); Overseas (incl. Eire) £30.00

REGIONAL CONTACTS

01/02 Devon/Cornwall Somerset/Avon/Wilts/Glos <i>Ivor Bryant</i> The Cottage, The Street, Alveston, Bristol BS35 3SX Tel: 01454 411028 ivor_bryant@msn.com	08 Oxon/Berks/Bucks <i>Roy Hocking</i> 69 Aylesbury Road, Berton Aylesbury. Bucks HP20 5BT rhock@btopenworld.com	14 N. Wales/Cheshire/Lancs Merseyside/Manchester <i>Peter Ketchell</i> 2 Manor Road, Westminster Park, Chester CH4 7QW Tel: 01244 676856	19 Ireland John Fitzgerald 17 Kilgobbin Heights Stepaside, Co Dublin, Eire Tel: 00 353 1 295 4299 Mobile: 00 353 (0)87 2556872 john.fitzgerald@electrolux.be
03 Dorset/Hants/I of W/Channel Isles <i>Colin White</i> 49 Grange Road St. Leonards, Ringwood Hant BH24 2QE Tel: 01202 873620	09 Beds/Herts <i>John Argent</i> 35 Brookmans Avenue Brookmans Park, Hatfield Herts AL9 7QH Tel: 01707 662049	15 Notts/Derby/Lincs/S. Yorks <i>Ken Sleight</i> The Forge Cottage Owston, Askern, Doncaster DN6 9JF Tel: 01302 337483	20 London/Middx <i>Jim Miles</i> 15a St Alban's Crescent Woodford Green, Essex IG8 9EH Tel: 07901 561866 (afternoons only)
04 Surrey/West Sussex <i>Julian Janicki</i> "Riverside" Blackbridge Lane, Horsham, W Sussex RH12 1RR Tel: 01403 251184	10 Essex <i>Dave Gustard</i> 44 Park Dale Danbury Chelmsford Essex CM3 4EH Tel: 01245 222921	16 North, West & East Yorks <i>Barry Diggle</i> 16 Croftlands, Idle Bradford BD10 8RW Tel: 01274 614729 barry.diggle@btinternet.com	Australia <i>Bill Ballard</i> 24 Rowan Ave, Boronia Victoria 3155, Australia Tel: 00 61 3 9762 9974 sfbill@bigpond.com
05 East Sussex/Kent <i>John Keenan</i> 41 Ghyllside Ave, Hastings E.Sussex TN34 2QB Tel: 01424 424323 elvabeach@btinternet.com	11 Worcs/Staffs/W. Mids/Warks <i>Geoff Salminen</i> 2 North Pathway, Carless Ave., Harborne Birmingham B17 9EJ Tel: 0121 427 2189	17 IoM/Cumbria/Durham/Tyne & Wear/N'umberlnd/Clvld <i>Trevor Walker</i> 4 Pauline Gardens, Denton Burn, Newcastle NE15 7TD Tel: 0191 274 5660 trevor@walke12.freeserve.co.uk	TRANSVERSE TORQUE is the official magazine of the Ford Y & C Model Register Ltd. Registered in England No. 4445646. Reg.d Office: Priory Close, St Mary's Gate, Lancaster LA1 1XB
06 South Wales/Hereford <i>Mike Samuel</i> "The Willows" Stoney Road Garndiffaith, Pontypool Gwent NP4 8PY Tel: 01495 772418	12 Leics/Northants/Cambs <i>Roger Hanslip</i> 165 Hungate Road, Emneth Nr .Wisbech PE14 ;8EQ Tel: 01945 430325	18 Scotland <i>Drew Barr</i> 30 Weavers Crescent Kirkcaldy KY2 5LN Tel: 01592 269266 drew@barr493a.orangehome.co.uk	DISCLAIMER: The Editor & Club Officers of the Ford Y & C Model Register do not necessarily agree with all the views and advice expressed within this newsletter and cannot accept liability from erroneous information printed.

Printed by CPS-Airedale
Leeds 0113 226 7497
Specialist Print for Classic Car Clubs

Editorial

I find it very difficult, whilst we are still in the dying throes of the extended summer warmth, to report that this is the Christmas issue of 'Transverse Torque'. To mark the occasion, we have a new design of front cover, thanks to the initiative of Steve Waldenberg, our printer. Even better, your Committee has agreed to splash out an extra £175 for Christmas for you to enjoy a colour cover. Each issue will carry a different photograph on the front cover, normally black and white, so please send in your better ones for consideration. Before it is too late, why not suggest items from **Regalia** or from the **Spares** list as Christmas presents to you from the family, or even treat yourself as a Christmas bonus! Whatever, your Committee and I wish you all a very enjoyable Christmas and New Year season.

I'm sure you are all aware that 2007 is the 75th year since the launch of the Model 'Y' in 1932. You will also be aware that we are trying to get 75 of our cars, in whatever state, to **Stanford Hall** at the junction of the M1 and the M6 on **Sunday 24th June** (the party will start on Saturday 23rd June!). That aside, the Model 'Y', or the Model 19 as it was originally called, was actually conceived in October 1931. So this issue of 'Transverse Torque' starts the celebrations early with the first of a series of historical articles covering the design, development and manufacture of the first 'streamlined' mass-produced car.

I must apologise for the drop-off in quality of the photographs in the last issue. I thought we had reached a permanent level of satisfaction. Some did not have the clarity of previous issues and one in particular – 'the young couple on the way to Brussels' – was way too small, which is probably why only one person came up with the correct identification. The answer was John and Carol Argent, our Regalia pundits. And the winner was roll of drums..... David Grace, from Boston Spa in West Yorkshire, who duly turned up at the All Ford Rally to receive the winner's kiss from Carol, only to be disappointed as John and Carol decided to give the rally a miss this year – or perhaps Carol is shy! As a consolation prize, Wendy Grace secretly sent in a photograph of David taken in October 1962 when he was at the peak of his rugby prowess, playing rugby union at that time for Selby RFU, before selling his soul and converting, professionally, to rugby league. Like me, he had hair then!

An early photograph of David Grace working on Wendy's Alpine tourer in 1962. Note the pre-MoT totally bald offside tyre!



I have been very frustrated over the past three months as my broadband has been down, resulting in me having to endure many hours of waiting for downloads on dial-up (I'm sure that is gobbledeygook to those of you who do not 'do' computers). What it means is that I have not been able to put as much time into preparing the magazine and building up the vehicle archive as I would have wished. Don't let this stop you sending in articles for publication, photographs, old log books for scanning and other historical details of your cars.

The 25th All Ford Rally, and the last with Bob Tredwell at the helm, was a great success in good weather, despite the soaking those coming from the north and the east had en route to Abingdon. The event is fully written up elsewhere in this issue. Another event announced in the Federation of British historic Vehicle Clubs (FBHVC) newsletter is the 2007 **'Drive It Day'**, when all classic vehicle owners are encouraged to show off their vehicles, either by driving them or, if not roadworthy, by parking them on the driveway for others to see. The aim is to raise the profile of the classic vehicle movement. The date for your diaries is **Sunday, 22 April 2007**. As this once again clashes with our Annual General Meeting at Willoughby, we hope you will combine the two events and bring your car along to the AGM.

Not to be outdone by Lord Montagu, seen in the last issue in his pedal car just under 80 years ago, Tony Hurst produced a photograph taken of him in his pedal car a few years later. His younger mate appears to be winding the starter handle to get some life into the machine. You can see by the sun hats that the photograph was taken in warmer climate than England. It was in fact in Ceylon (now Sri Lanka) in 1947/48. Tony's love of the Model 'Y' probably goes back to that time.



Tony Hurst and friend with Tony's pedal car

A nice tribute to Lord Montagu on his 80th birthday came from Dave Bond, in County Durham. He writes, "I thought this photograph might be of interest to 'Transverse Torque' readers, noticing the picture in the last issue of Lord Montagu taken outside Palace House, when a small child in his pedal car. I was reading *Classic Car Weekly* (Sep 28th) and, lo and behold, there was a picture of him again outside Palace House, the difference being now rather than then! I think he does a lot for the classic car movement. Long may it continue."

In this issue

Chairman's Chat	5
Secretary's Ramblings	5
75th anniversary of the Model 'Y'	6
For sale	7
Members' correspondence	9
20 years ago	10
NEW MEMBERS	11
Ford Day – Gaydon	12
International correspondence	12
FBHVC News	16
All Ford Rally	16
Regional news	18
Spares report	20
Tappets	22
The Powerscourt Estate Picnic Run	22
More Post Cards	24
Brake shoes & TRE's	25
Events	26
Members' cars	27

Photograph on front cover

The winner of the Eric Buffon shield at this year's All Ford Rally, our Secretary, Bob Wilkinson, for his painstaking restoration of the June 1936, ex-Ford Heritage Centre, Dagenham, 'CX' tourer, EMF 151.

Lord Montagu outside Palace House this year. His pedal car has been replaced by his Rolls Royce Silver Ghost – big boys' toys!

Another pedal car belonged to David Gustard's friend as he recalls:- "Following Bob Wilkinson's request in 'Secretary's Ramblings' for old photographs of member's pedal cars, I thought that you might like to see the attached photograph. It shows me proudly sitting in the driving seat of a Jeep which belonged to my friend Brian Powell, who is standing on the right. My sister and friend are eagerly awaiting a drive. The photo was taken in 1946 and as the War had ended a year earlier this was a very desirable vehicle to be seen in. The specification included solid tyred wheels and simulated silver painted headlights. There was only one other pedal car in the neighbourhood that was better and that had pneumatic tyres and working lights. I spent some time pedalling this jeep around. I think it was probably the driving experience gained from the solid wheels, lack of brakes and slack steering that lead me to easily relive the experience when I spent £5 and purchased my first Model 'Y' in 1962."



Two new members this month with cars worthy of comment. Firstly, Bob Brown has bought the short rad Tudor, which has been in the Chapman's stable for many a year. What a shame that its registration, MJ 3118, has been sold by Mike Chapman, to be replaced with a meaningless 449 UXP - putting monetary gain above birthright! With Mike's previously well-respected association with old Fords, I am surprised at this blatant disregard for originality and provenance. Name and shame I say! The second car is a new one to the register. It is amazing how many still come out of the woodwork, especially in Essex and East Anglia. We welcome Arthur Taylor, who joins us with a March 1937 £100 Ford "Popular".

A lovely re-discovery appeared on ebay in September. It was the pink and brown December 1933 Model 'Y' pick-up which was exported to New York in 1981 by member Bill Norris. It was being sold by Brian Ellebracht, who gave a very full description of the vehicle in his ebay write-up. It has been bought by Richard Hosner who, hopefully, will be a paid up member by the time you read this.



The very tidy looking pick-up sold on ebay in September. This was exported to New York in 1981 by member Bill Norris.

A number of members have pointed out to me the letter to the Editor of 'The Automobile' in the October's issue, written by our very own Bessie Hickson, in which

she is less than complimentary about husband, Doug's, expertise with a DIY welding kit; suggesting that his health and safety record in his workshop cum shed leaves much to be desired. I wouldn't stand for it Doug. I suggest 100 lines and fillet steak every night for a week!

Non-member Dave Collins sent in some photographs taken at stock car race meetings over the past two years. You will remember, in 2004, we ran a couple of articles on the history of stock car racing in the UK to celebrate the 50th anniversary of its introduction into the country over Easter, 1954 (issues 145 and 148). Geoff Dee is our own stock car driver and expert and may be able to tell us about No. 333 shown in the accompanying photograph.

A Model 'Y' 'Junior' class stock car No. 333 at the Northampton International Raceway in 2005.

Finally, I urge you all to look at the **Wanted** advertisements in the magazine. We all have bits stored away in garages, sheds and attics which could be just what another member wants for his restoration. Please help those still striving for perfection.

Sam Roberts

The deadline for copy for Issue 164 is Friday, 29th December 2006



Now that's what I call a pedal car! David Gustard steals a drive in his friend's girl puller!



Chairman's Chat.

As we pass from 2006 into 2007, I look back at my few months in the chair with the knowledge that we have had a successful season, to be topped off with the Y&C Register stand at the Classic Car Show at the NEC at the end of October. Although it only involved 20 or so of our cars, the trip to Holland was the highlight of the year, and was very well organised by our Dutch members. Why more members do not join us on our longer ventures surprises me. There were other, more regional events around the country, which were well supported and, from the reports in the magazine, were all enjoyed by those taking part.

I must thank the committee and the other active members for their contributions in 2006, which make the Y&C Register such a friendly and helpful club to belong to. I must particularly thank our spares organisation, which has improved the service to members significantly. However, we must not be complacent as there are some 1500 cars on the 'List of Known Surviving Vehicles' and we have only 400 members. Recruiting is every member's task so please encourage other owners to join us in 2007.

The launch of the Model 'Y' in 1932 makes 2007 a special year; the 75th anniversary. The main event of the year will be the gathering of our cars and some events at Stanford Hall on Sunday, 24th June. The party will start on the Saturday in the camping field for those staying overnight. We want to get 75 cars together on the Sunday, so highlight the day(s) in your diaries. We will be considering other activities at our committee meeting in early November.

In the meantime, may I wish you all an enjoyable Christmas holiday and a healthy and happy 2007 of motoring or restoring.

Peter Ketchell, Chairman.

Secretary's Ramblings.

This is our Christmas issue and I wish all members and their families all the best for Christmas and the New Year and ask, "Where did 2006 go?" There is still time to suggest a Christmas present or two from our spares, handbooks or regalia selections. Track rod ends wrapped in tinsel can make a Y & C man (or woman!) very happy!

Due to the lead in time for each magazine, I write this at the end of October just after the **All Ford Rally** and before the **NEC Classic Car Show**. The All Ford Rally weather was gloriously warm for once after a very wet start to the day, as I drove the 80 miles from home to Abingdon in my 'CX' tourer hood down all the way. I got soaked but soon dried out though and enjoyed the event and our best club display – certainly that I can recall!

The year has gone very well in many ways – the event highlight being the memorable and well planned '**Raid Holland**' tour in June. Members have also mentioned various regional and local events they have enjoyed around the country. New members are always impressed by the extensive way in which our cars are used in attending tours and local events – reflecting the initiative from the FBHVC to 'Drive It' (remember the national **Drive It Day** in April?) rather than let our cars become static museum pieces. I enjoyed restoring my 'CX' Tourer but I enjoy using it even more.

Cellulose paint will not be on sale after January 2007, unless you have a licence to use same, following recent EU rules. This will seriously affect the amateur/home sprayer like me, who will be seeking suitable alternatives, as many modern paints need special handling facilities. I guess our membership includes experienced paint sprayers who can advise of alternative ways forward, without our need to spend a fortune on air-fed masks, ovens and the like. Please write in with your advice or experience on these matters.

Time wasters are indeed a nuisance. I refer to those who advertise spares and cars etc., which do not live up to expectations. Recently I went some 80 miles with a friend – he took a day off work unpaid - to look at a quantity of spares and a car. The vendor (not a member) had promised, and had taken weeks to prepare for our visit, that all the spares would be

available to view in one location. On the day we were able to see only a small, less exciting, selection and were told that for domestic reasons the remainder was not accessible. A further 15 mile journey revealed a car that was probably worth only about half the asking price and was not as described. We had gone with enough cash but bought nothing and wasted a day and fuel when we could have been doing something much more positive for our hobby. The other time wasters of course are those who are not serious buyers. Somewhere in here there is a message for our Club members to treat each other – whether buyers or sellers – with more care and consideration, particularly where travelling some distance is involved. Car adverts in our magazine and on our website always carry an asking price and we seek to encourage members to advertise at a sensible asking price. This hopefully will avoid some of the potential pitfalls outlined above. **In addition, we do not include registration marks** to reduce the potential for those perusing our adverts to buy a car simply to rob it of the number plate. Often cars are robbed in this way, only to turn up again for sale by the number plate dealer, at the same price, but now carrying an age related number. Genuine car enthusiasts then buying such a car are paying subsidies to the number plate trade. Cars which have been the subject of number transfers are worth from 15% to 20% less than with the original number.

My thanks go to all Club officers and members who have contributed to a successful year in 2006. **2007** promises to be a busy year. Your Committee is endeavouring to increase Club services and spares availability, but we do need new faces with useful skills and experience to step forward and become involved. What can you do for your Club ?

Chairman Peter Ketchell is anxious to ensure a successful meet in June 2007 at Stanford Hall (near Lutterworth) to celebrate the **75th Anniversary of the Ford Model 'Y'**. **WE WANT YOUR CAR/VAN/TOURER THERE** on parade get busy over winter and book your place in due course as news comes through the magazine. A greater percentage of our cars become roadworthy each year as restorations come to fruition..... don't worry if your car is not completely finished for this event just get it there.

Please use your car as frequently as possible over the winter on those fine if cold days. Our old cars do not like standing idle for weeks and months and they are taxed and insured for the whole year, so wrap up well and get out and about.

Seasons Greetings !

ACCOUNTABILITY AND RESPONSIBILITY

EVERYBODY, SOMEBODY, ANYBODY
OR NOBODY?

There was an important job to be done and **EVERYBODY** was asked to do it.

EVERYBODY was sure that **SOMEBODY** would do it.

ANYBODY would have done it but **NOBODY** did it.

SOMEBODY got angry about that because it was **EVERYBODY's** job.

EVERYBODY thought **ANYBODY** could do it, but **NOBODY** realised that **EVERYBODY** would not do it.

It ended up that **EVERYBODY** blamed **SOMEBODY** when actually **NOBODY** asked **ANYBODY**.

"I include this little piece above in this issue as a reminder that our club is still seeking a replacement for Sam Roberts as Editor – you will recall that Sam has asked to stand down to concentrate on the archive side of club work. Perhaps this will stir the conscience of someone to step forward. Wherever you are will **SOMEBODY** contact me, please!

Bob Wilkinson. Secretary.

Bob's Joke Corner.

WHO SAID MEN AREN'T SENSITIVE

A woman meets a gorgeous man in a bar. They talk, they connect and sure enough they end up leaving together.

They get back to his apartment and she notices that his bedroom is completely packed with sweet colourful cuddly teddy bears, hundreds of cute small bears on a shelf all the way along the floor; cuddly medium sized ones on a shelf a little higher, and huge enormous bears on the top shelf along the wall.

The woman is surprised that this guy would have a collection of teddy bears, especially one that's so extensive, but she decides not to mention this to him, and actually is quite impressed by his sensitive side.

She turns to him... they kiss... and then they rip each other's clothes off. After an intense night of passion with this sensitive guy, they are lying there together in the afterglow, the woman rolls over and asks smiling, "Well? How was it?"

The guy says:

"Help yourself to any prize from the bottom shelf."

The sender wishes to remain anonymous but you don't have to be.....so send me your favourite story.

Bob Wilkinson.

75th anniversary of the Model 'Y'



The Ford Y&C Model Register is formally celebrating the 75th anniversary of the launch of the Ford 8h.p. Model 'Y' next year, in 2007. The production model was unveiled at the Ford Motor Exhibition, which was held at the White City, London, from 13th to the 22nd October 1932. However, the design and development started one year previously, in October 1931, so we start the celebrations now, with this issue of 'Transverse Torque'.

First a bit of background. Sir Percival Perry, the Chairman of Ford Motor Company Ltd. had been asked to rejoin the company by Henry Ford in 1928 after nine years absence. Henry and his wife, Clara, had been visiting England earlier that year and had confirmed Dagenham as the site for the new factory to replace the overstretched Trafford Park site in Manchester. The build of Dagenham started in May 1929 and was ready for production in October 1931 (another 75th anniversary!). On rejoining the Company Perry had proposed 'The 1928 Plan' to Henry Ford, making Dagenham the provider of manufactured vehicles for Great Britain and for 'knocked down' (KD) vehicles for assembly at a number of European plants and, through the Ford Motor Company of Canada Ltd., the British Empire. Henry and Charles Sorensen, his overseas manager, had both agreed to the plan.

Until the middle of 1931, Sir Percival Perry was looking to the under-powered Model A, the AF (F for Foreign to U.S.A.), to be the car to save Ford's fortunes in Europe. The Model A, introduced in 1928, had been a disaster in Europe because of the high 'road tax' it attracted at 24 fiscal h.p. and high petrol consumption (tax on petrol had been introduced in 1928). Added to which, the Wall Street Crash of October 1929 and the subsequent Great Depression had put the purchase of a large car well beyond the pocket of the ordinary public. The Model AF was the same as the Model A, but with a smaller cylinder bore (3.05 inches) and consequently a lower 'road tax' rating (14.88 fiscal h.p.) But when it is considered that the long stroke and small bore of the Le Mans Bentleys only attracted a fiscal h.p. rating of 16, the 'square' engines of the American cars, i.e. same size bore and stroke, did not stand a chance in the very competitive European market against the likes of the Austin 7 (fiscal h.p.), Morris 8, Standard Nine, Peugeot, Citroën, Opel, Fiat, etc. Even the relatively big Austin 12, introduced in May 1931, sold for only £199 compared to £215 for the Model AF. The only solution to save Ford was a 'Baby' car for Europe.

Following his visit to England in 1928, Henry Ford had realised that he needed a small car for Europe and, allegedly, had shown some sketches to Perry. It was not until mid 1931 that Perry spelt out the required parameters formally to Ford in Dearborn. He stated that the engine should be small enough to qualify for the British 8 f.h.p. vehicle excise duty and have a lively performance. The car should have a wheelbase of no more than 90 inches and be cheap to buy and operate. It was on the 1st October 1931 that Henry's son, Edsel Ford, now the President of the Ford Motor Company, took this requirement back with him to Dearborn after opening the newly built factory at Dagenham.

It was necessary, not only to introduce the small Ford as soon as possible, but to convince the motoring press and the public at large that a small Ford was imminent. Two projects were started in October 1931. The first, under the management of Lawrence Sheldrick, was to produce 14 copies of a concept car to be displayed at The Royal Albert Hall in London and in other European capitals in February 1932, allowing only four and a half months for production! This would act as a sop for the press and, it was hoped, would help sales of the production version later in the year by persuading the public to delay the purchase of a new car. Sheldrick was the Company's chief engine designer who had been deeply involved in the development of the V8 engine. His right hand man in the project was Joe Galalmb, a Hungarian immigrant to the U.S.A., who had been Henry's right hand man in

the original design of the Model T. He had also helped Edsel in the styling of the Model A and had just finished working on the Model B.

The introduction of the Model B had been delayed until manufacture of the V8 engine had been perfected. With the V8 engine incorporated, the straight four cylinders Model B was marketed as the Model 18, i.e., the first car (1) with the V8 (8) engine. In the interest of time, Sheldrick's concept car was basically a scaled down Model B. Being the next car to be designed after the Model 18, the small Ford was known as the Model 19.

"The Hungarian born Joe Galamb, who was Henry Ford's right hand man in the design of the Model T and who played a major part in the design of the Model A and the Model B. In October 1931, Joe was tasked to design the body for a concept 'Baby' car for Europe.



The second project was managed by another immigrant Hungarian, Eugene Jenó 'Gene' Farkas, with a strong team of designers and stylists in support. Particularly notable in the team was Lawrence Sheldrick who, in addition to overseeing the concept car project, was also tasked to design and develop a small bored engine in double-quick time to compete with the small European cars, about which he knew very little. Gene Farkas realised that it was the body styling which sold cars more and more so, no doubt encouraged by Edsel's body styling expertise, recruited another Eugene into the team, Eugene 'Bob' Gregorie, a 23 year old designer from the Ford-owned Lincoln Motor Company. Bob Gregorie was to design the first mass-produced 'streamlined' car in the Model 'Y', a feature which, arguably, was the main reason it became so popular and saved Ford in Europe. The plan was for the production Model 19 to be ready for manufacture in Dagenham by June 1932; leaving only nine months for the car to be designed and developed and for all the special machinery to be bought (mostly in the U.S.A.), shipped and commissioned on the factory floor at Dagenham. A very tall order! It is believed that 12 pre-production cars were built to meet this development programme.

The Ford Motor Company's senior designer, Gene Farkas who, in October 1931, was given the responsibility for designing and developing the production version of the Model 19 for manufacture in Dagenham in nine months time!

And so the two projects proceeded in parallel, in secret, in the Ford Engineering Laboratory in Dearborn.

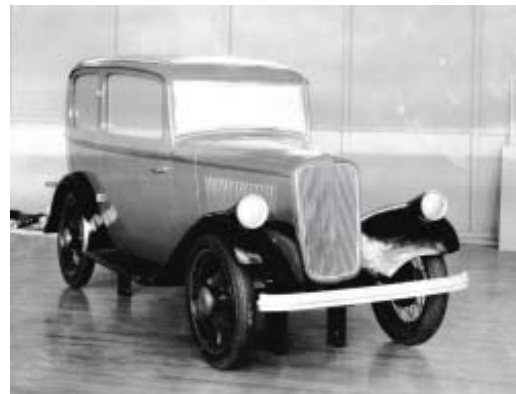

Joe's experimental clay model for the body styling of the prototype concept Model 19. Note the moulding of the headlamps into the front wings, a fashionable design feature of the early 1930s emanating from the Pierce Arrow stable. The style was not adopted on the Model 19 as the manufacture of the wings was too complex.

For sale

January 1937 Ford Model 'Y' 5 cwt van (Y170658) which, although not immaculate, is in very sound condition and is to be sold with new MOT etc. It is fitted with a Model 'Y' 8hp engine (rather than post war replacement). A new wire loom has been fitted. The panels are sound and solid, however it could do with a repaint (a very amateur job at present). Woodwork is good. I am seeking nearest to £4250. **Paul Beck. Initial contact by e-mail (<http://www.vintagecarparts.co.uk>) or telephone 01692 650455 (working hours)**

Colour photocopies of the 1933 Royal Albert Hall, Ford Exhibition, advertisement (2 sides) from the Autocar magazine (October 13th 1933), plus a black & white page write-up on the show - all in plastic folders - £6.00. 8 sides of Ford dealer black and white advertisements from the same Autocar magazine in plastic folder - £3.50. Both items for £9.00 **Ron Kendall. Tel: 01827 714584 (Atherstone, Warwickshire)**

Wanted

Repeat: - Ammeter for a long rad Model 'Y'. Surely someone out there has a spare on the shelf or in a box in the garage!
Dave Bond. Tel: 07967 921212 (Co. Durham)

10hp. early/pre-war engine with side water manifold in any condition "dead or alive" for rebuild. Short engine or even 8hp considered.
Harvey Wash. Tel: 01376 571718 (Colchester)

Does anyone have a spare horn off a later 12v small Ford that they'd be willing to sell me? The truly ear-shattering Klaxon retro-fitted on BDD, my Model 'Y', is embarrassingly (and painfully) OTT for the old biddy.
John Osley. Tel: 01745 822620 (Abergele, N. Wales)"

Right/hand running board for 1935 long rad Tudor Model "Y".
John Armstrong Tel: 01937 832450 (Tadcaster, N. Yorkshire) email: j.armstrong@st-peters.york.sch.uk

Sam Roberts

That accident

Member Tony Etheridge, our recommended tyre supplier (see 'Useful Contacts'), sent in a copy of the photograph of the upturned Model 'Y' taken 'in the mid-1930s', that appears in Lord Montagu of Beaulieu's book 'The British Motorist'. Tony says, "Another [photograph] for the archives from a book The British Motorist (published 1987) that I picked up at a car boot sale."

We have included this photograph before in the magazine, but I was blown if I could find it amongst the albums of photographs in the archives. I asked Tony to send his copy of the book, so that I could scan in a good quality image. This he did remarkably quickly. When it arrived, I realised that we had a copy of the book in the Register library after all. Stupid boy! The book was returned just as quickly. Thanks Tony.

Members' correspondence

photographs of the last time that his father



Woops! An accident in the mid-1930s. The rather new-looking Tudor Model 'Y' in the background is registered DKT 46, which is a March 1937 Kent registration and the large Dodge at the top of the hill, DCD 6, a late 1936 Brighton registration. This points to the accident being on the South Downs, probably in 1937. I can't quite make out whether there is an AA or RAC badge on the sidecar parked by the side of the road, but the goggled mechanic looks pretty nonplussed.

had the car on the road, which was to take Graham's son, Michael to church for his wedding in September last year. Graham's other son, Robert, was Michael's best man and also travelled to church in the car.

The late Peter Coope



The late Peter Coope presents his Model 'Y' to take his grandson to church for his wedding – 3rd September 2005.

It is with regret that we heard of the death of member Peter Coope on New Year's Eve last December near Stafford. Godfrey Dingley-Jones, on behalf of the Y&C Register, sent our condolences to his two sons, who are looking after his Model 'Y' and have no plans to part with it as yet. Graham Coope sent in some

As Graham explains, "My father, Peter Coope, was an experienced mechanic who was in business for over 30 years as a haulage contractor. He is greatly missed by us all."

two linked events which happen at the same time without each being aware of the other. It happens quite frequently in the day-to-day running of the Club.

You will see in the All Ford Rally write-up in this issue that Ken Wilding's Fordor Model 'Y' with boot, DKO 301, won the Class 2 top

award at the show. A week later, Billy Beattie, on the Isle of Man sent me a copy of his new log book showing the change of number of his Model 'Y' Tudor from FPF 458 to CMN 837, which I had already typed out for interest – see next page.

In with his log book, Billie included a photocopy of page 12 from Issue 98 of 'Transverse Torque' (January/February 1996 - ten years ago) in which I reported on the Clarke &

Simpson Auction at Leiston on the east coast of Suffolk at which there were no fewer than 5 Model 'Y's and 163 other vehicles under the hammer, the property of John Keeble of The Garage, Theberton. Brian and Yvonne Mace were present with sandpaper, wire wool and camera to gather the necessary numbers from these hitherto unknown survivors. There are photographs of two of the cars on page 12. You've guessed it; they were DKO 301 and FPF 458!

Close-coupled or what?

Yvon Precieux, our erudite pundit of 'Sidevalve News', Pre-war Register fame, has entered the fray on the meaning of 'Close-coupled'. He writes from his lofty castle overlooking Wemyss Bay in Scotland, "In the latest magazine you mention the Jensen Model 'C' DHC and what is meant by "close coupled"? Bill Ballard has referred to Nick Walker's book 'A-Z British Coachbuilders 1919-1960', but Nick seems to have included some of his own ideas in defining this term.

Strictly speaking it has nothing to do with either the wheelbase or the luggage space. The term "Close coupled" or "Short coupled" denotes to bodywork styling only, in which the front and rear row of seats are set closely together to achieve a comparatively short passenger area. This does not automatically qualify that it should be within the wheelbase, although most comparatively are. True examples of close couples coupe bodies of the 20s and 30s could be seen on lengthy chassis such as Hispano-Suiza & 8 litre Bentleys. Intentionally this body styling gave more emphasis to sleek long bonnets and extra long tails, the latter automatically giving provision for a larger volume of luggage to be carried. On mass produced, shorter saloon type chassis, this was and is far less obvious. We enthusiasts seem to accept bodywork terminology used by recognised experts as being right and proper without real knowledge of what was meant. Out of print, but the most definitive of references on bodywork is the book by Ian Beattie, "The Complete Book of Automotive Body Design.", published by Haynes"

Thanks Yvon for that.



Billy Beatties Tudor on the Isle of Man with its newly issued, very appropriate registration.

An appropriate re-registration

You will recall in issue 161, we congratulated Billy Beattie on the Isle of Man on 30 years of his company, Mann Auto Sales. We showed the picture of him, his son, Paul and John Fenton with Billy's Model 'Y', FPF 458. Needless to say, Billy was less than happy with his DVLA issued age-related number and approached them for an Isle of Man age-related registration number.

Billy's Model 'Y' (Y183288) was manufactured in April 1937. DVLA, bless 'em, issued him CMN 837. CMN was issued on the Isle of Man in April 1937! Unfortunately CMN 837 wasn't issued until a year later, but Billy has no qualms about that. As can be seen from the accompanying photograph, with a slight gap between the 8 and the 37, he makes the point that he has a 1937, 8hp car!

Billy proudly wrote:- 'I am now road legal, passed the test and taxed for the road. Hope you like the number.'

I first came across Billy's car in December 1995. It was advertised for sale by David Howard Cars Ltd. near Romsey, here in Hampshire. It was a rather untidy black thing at that point with its FPF registration number. Member Lester Bennett was the next owner. He restored it to its present standard and painted it dark green and black. I have asked Billy if he has inherited the log books or any other old documentation which might shed light on its original registration number.

New registration plates

Paul Beck who heads up Vintage Car Parts and its subsidiary, Small Ford Spares, responded to my request for information on sourcing black and white number plates for our cars. He e-mails:-

"DVLA number plate detail - the facts that you quote for having to produce the substantial wad of document is quite correct. It is a tad over the top? However, the statement that 'Halfords also have to report the details to DVLA' is not correct. We ([http://](http://www.vintagecarparts.co.uk)

www.vintagecarparts.co.uk) are registered number plate suppliers, and we ONLY supply black background (aluminium or white digit) plates. We have to retain the data that you as a buyer offer for a period of 3 years for possible DVLA inspection. Please note that the correct digit size for the Y & C vehicles is 3.1/2" compared to the later 3.1/8" high post -1963 size."

John Osley also bought some plates through the other arm of Paul Beck's organisation - Small Ford Spares:-

"I had some replacement number plates made for BDD, as the ones on the car were some awful 20s pastiche with tiny lettering. As you describe, I sent the required bumpf off to "smallfordspares" and within two or three days had back a set of very smart 'in keeping' plates direct from a company in Blackpool. So, excellent service there.

Model 'C'/'CX' door handles

Paul Beck also reports:- "Some while ago we sought patterns to enable us to make locking and non-locking Model 'C' handles in both Left and Right form. Well nothing appeared, so we decided to make our own. We have these done now (chrome on bronze) so locking handles can be fitted to either side of the front doors!

<http://www.vintagecarparts.co.uk>"

My first Model 'Y' - David Gustard



David Gustard with a full mop of hair in 1961 in the passenger seat of RD 9927. Was Jackie driving? Note the add-on direction indicators on the sides of the roof.

In response to Bob Wilkinson's request for a photo of my first Model 'Y', I enclose a photograph taken in 1961, whilst on holiday at Wembury near Plymouth, Devon. I had driven the car from Hornchurch in Essex, through central London and along the A30 to Exeter and A38 to Plymouth. On board was my fiancé, Jackie, my parents and two large suitcases. The Model 'Y', registered RD 9927, was a black 1937 two door. In addition to the holiday in Devon, we completed many memorable journeys in the car during the three years we owned it. Sadly, as a result of some serious 'Ten Year Test' failures, it went to the breakers yard in 1964.

I'm not moving - sequel.

Further to the minuscule glimpse of Ivor Bryant's Model 'CX', which was captured in an estate agent's house photograph - see page 10 of the last issue - we now have a more detailed picture of the progress Ivor is making on his restoration of the car. I don't suppose it will be ready for the Bristol Classic Car Show at Shepton Mallett on 17/18 February.

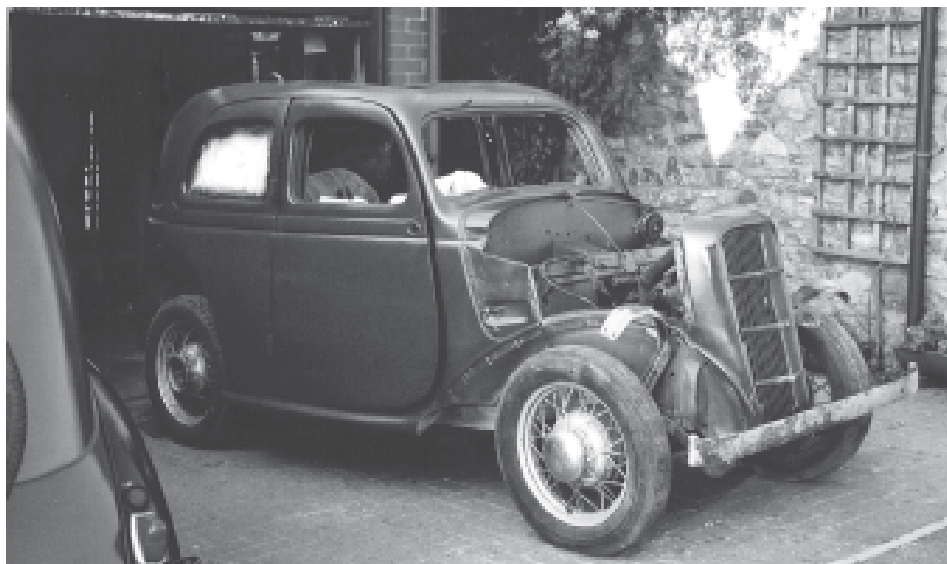

Real progress on Ivor Bryant's Model 'CX' restoration in Somerset.

The 1933 Ford Motor Exhibition

In the 'For Sale' advertisements in this issue, Ron Kendall is selling good quality copies of October 13th 1933, 'The Autocar' coverage of the 1933 Ford Motor Exhibition in colour. This was the motor show which launched the even better Model 'Y', the long rad, onto an unsuspecting public, which was just recovering from the financial stringency of the Great Depression following the Wall Street Crash of 1929.

I note in our archive copy of 'The Autocar' advertisement that the air-brushed pictures of both the Tudor and the Fordor models show the cars with straight, single grooved front bumpers without the characteristic dip in the middle, which was a fashionable design feature of the early thirties' American cars. 'The Autocar' had obviously been given very early sketches of the cars by the Ford Motor Company as the first long rad promotional literature from Ford, dated September 1933, a month earlier, showed the dip.

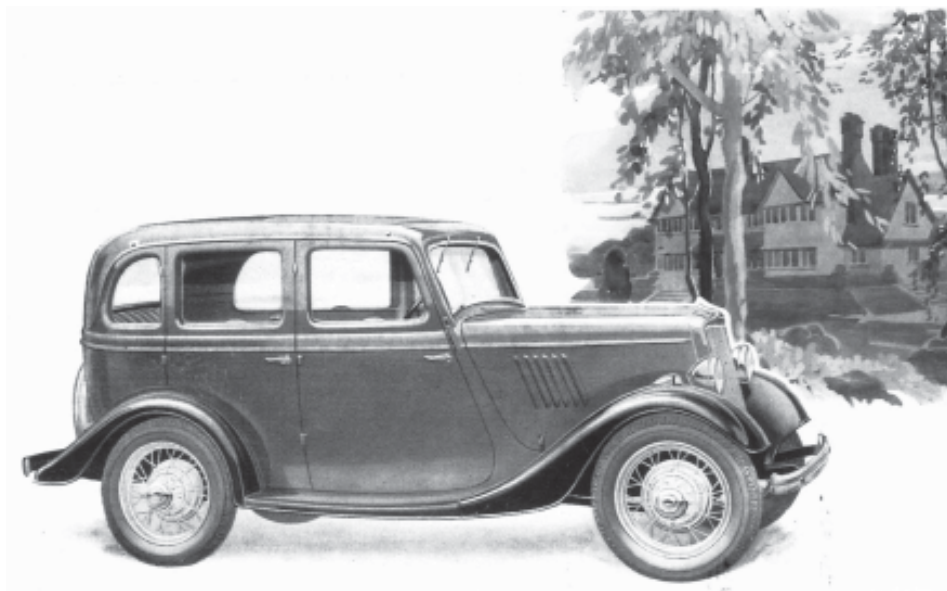

The Autocar' portrayal of the long rad Model 'Y' in the 13th October 1933 edition. This picture shows the 1934 Fordor model, which was only manufactured in 'de luxe' form; hence the 'rustless' steel headlamps, sidelamps, twin wipers, chromed windscreen surround, etc

20 years ago

– Issue 44, November/
December 1986

Issue 44 had a distinctly Christmas flavour about it, four pages being devoted to illustrating pages from catalogues advertising Christmas gifts for the motorist, including a Bakelite pipe holder which was screwed to the dashboard. I really must look out for one of those at autojumbles. Being two years into a self-imposed twelve-year smoking ban, a pipe holder will make an ideal eightieth birthday present to myself. I do miss my pipe!

It is always fascinating to look down the list of new members in these old issues. Names, in the main, who have come and gone over the past twenty years, each doing his or her bit to keeping our old cars on the road and, in many cases, contributing to the smooth running of the Club. In issue 44 were three names of members still serving. Firstly, Liam Tomlinson, who was looking for a Model 'Y' when he joined. He has since found a smart Tudor and after much prodding has found its chassis number for the register of survivors! Hopefully, once he frees himself from the rigours of the diamond trade, we will see him and his car more often at shows.

The second 'new' member was Philip Wookey, from near Bristol. Philip had two Model 'Y's on joining, one of which he had already been driving for 13 years. This is the car we have recently featured with the red 8HP radiator spoon badge. Did the car have the 8HP badge when you first bought UD, Philip? Philip's second car was awaiting restoration and is now on the road.



Philip Wookey's first car, which he has now owned for 33 years, at this September's Great Dorset Steam Fair. Ford on Philip!

The third, still serving, new member was Robert Donovan from Kent, who had just bought the partially restored Model 'CX', EMK 803. In

this issue, he tells the brief history of the car:-

"The original owner, Mrs Sweeting, nicknamed my car 'Micky' and she drove it all over London and the Home Counties, before and during the war years. Soon after the war, she moved to Tunbridge Wells in Kent (I know this by the date stamps on the Vehicle Excise Licences, July 1949). She then continued to drive 'Micky' until the end of September 1952, when she decided that the war and some 16 years of motoring had taken its toll on 'him' so she took 'him' off the road for a short spell while her husband, Victor, could restore it. By now the car had covered some 63,000 miles, so parts needed replacing, which Victor duly started by replacing the wings, brake linings, fuel tank, re-plated the chassis in one or two places and repainted the body. However, he didn't like the finish to the doors, so he removed them and on doing so, discovered that the lower edges and seams were corroded. Being a working garage owner and short on time, he sent the doors away for repair.

On their return, he wasn't satisfied with the work carried out, so putting them to one side of the garage, he decided he would repair them when he got time!!

And so it came to pass that on 5th July 1986, some 34 years after 'Micky' was 'taken off the road for a short while', I found him. Here's hoping fellow members find the story of 'Micky' interesting and to remind everyone of the dangers of saying "I will put that there and do it when I have time.""

"Robert Donovan's Model 'CX' as he found it in 1986, still as Victor Sweeting had left it some 30 years previously. The doors were still leaning up against the garage wall. By 1990 Robert had EMK back on the road in nice gunmetal grey paintwork.



Coincidentally, three weeks ago, in August 2006, Robert sold her to a very nice man in Sandwich, Kent, who hopefully will be a signed up member by the time this magazine hits the doormats.

The programme and the different vehicle classes at the All Ford Rally were fully described by Chris Sanders, the then Secretary of the Pre '50 American Automobile Club. Chris then joined the Early Ford V8 Club of America, in which he is still very active. The All Ford Rally took place on the Abingdon Town Cricket and Football Clubs' ground. I remember it well. It was very cramped and 'Spanner's' continuous and loud West Country voice gave you a headache by the end of the day. I remember Geoff Dee and I considering cutting the wire to the loudspeaker on the pole nearest our site!

Graham Miles, aka 'Chief Nutter', gave his Chairman's report, mainly on the ongoing spares manufacturing sagas. Do we need roof stick kits for Model 'C's? The sills for Model 'C's seem not to fit too well, one had been returned. Should we invest in rear patch kits for Model 'C's? He had found a chap in Birmingham who would make the inside door handles for the Model 'C' in the original alloy. However, the man who was to make bumpers and hub caps had put our order back until after Christmas as he was too busy! Peter Ketchell had collected some king pins from Manchester, but wasn't 100% sure whether they were Model 'Y' or Model 'C' ones. And so on. Dear Graham, his journey in the spares manufacturing business was never a smooth ride, but didn't he do well!

Sam Roberts.

NEWS OF NEW MEMBERS

Prepared by Godfrey Dingley-Jones - 9 October 2006.

Since the last issue of 'Transverse Torque' we are pleased to welcome to the Y&C Model Register the following seven new full members, including one member who has rejoined.

Robert Brown	B1202
	Towcester, Northamptonshire
Thomas Gray	G1804
	Montrose, Scotland
Melvyn Fox	F0402
	Esher, Surrey
Robert Pavitt	P1012
	Epping, Essex
Arthur Taylor	T1016
	Navestock, Essex
Robert Tyler	T1005
	Hornchurch, Essex
Peter Udall	U1101
	Nuneaton, Warwickshire

We are delighted to welcome these new members. Brief details of their vehicles are as follows:-

Robert Brown from Towcester has a December 1933, 2 door short rad Model 'Y', green over black. The chassis number is Y30274 and it has the registration number 499 UXP (formerly MJ 3118). Bob is currently carrying out a full restoration, including a re-trim. Thanks for joining the Club and we hope the restoration goes well. Please keep us updated with your restoration progress.

Thomas Gray We would like to welcome Tom from Montrose to the Club. Tom has a 4 door short rad Model 'Y' which was first registered on 20 June 1933. It is blue over black and has the chassis number Y26895 and registration number FS 6332. Bob tells us that the car is almost in 'on the road' condition. We wish Bob all the best with the last of the restoration.

Melvyn Fox Melvyn from Esher in Surrey has joined the Club and is the proud owner of CYH 780, which is a 1933 Model 'Y' Fordor in black with a chassis number of Y140682 and a Briggs Body number 164/4354. Melvyn purchased the car from ex-member Dave Lovering of Great Dorset Steam Fair fame. The car is in an 'on the road' condition and we wish Melvyn all the best with the car.

Robert Pavitt from Epping has re-joined the Club. Robert has an April 1937 Model 'Y' Tudor, chassis number Y182173 with a Briggs body number 165/64960, amongst a large collection of other cars and agricultural machinery. We would like to welcome Robert back to the Club and wish him success now that he has decided to restore this particular car.

Arthur Taylor We would like to welcome Arthur from Navestock in Essex to the Club. Arthur has a black Model 'Y' Tudor first registered on 30 April 1937. The chassis number is Y182169 with a Briggs body number of 165/64716 and he hopes to recover the original registration number of EVW 961 using the services of the Y&C Register through Bob Wilkinson. The car is being restored and we shall be pleased to learn how the restoration is progressing in due course.

Robert F Tyler We welcome Robert from Hornchurch in Essex to the Club. Robert has a Model 'Y' Tudor first registered on 10 July 1935. The car is blue over black with a chassis number of Y102796, a Briggs body number 167/10212 and the registration number is CKJ 103. Robert purchased the car, which is in 'on the road' condition, from ex-member Jeff Bromfield. Thanks for joining the Club Robert and we wish you well with the car.

Peter Udall from Nuneaton in Warwickshire has joined the Club. Peter has bought a Model 'Y' Fordor, maroon over black with a chassis number of Y40484 and a Briggs body number 166/146. The car, which is in on the road condition, was first registered on 2 November 1933 and has the registration number KV 6606. Peter became aware of the Club following the discovery of a copy of 'Transverse Torque', Issue 140 dated January-February 2002 which was left in the car. Welcome to the Club Peter and we hope you enjoy many years of motoring with your Model 'Y'.

I hope you will find this contribution to 'Transverse Torque' informative and, as always, the Club extends a warm welcome to all new and re-joining members. Sam Roberts, our Editor, will be pleased to receive any news and photographs of your vehicles.

SUBSCRIPTIONS

Following my plea in the last issue of 'Transverse Torque' I am disappointed to report that I have NOT been inundated with requests for Standing Order forms, having received only one request.

If you would like to pay by Standing Order please let me know and I will send you a form. You will find all my details on the inside cover of 'Transverse Torque'.

Godfrey Dingley-Jones
Membership Officer

Ford Day - Gaydon July 2006.

"The two Geoffs", Dee and Salminen organised our small collection as part of this annual show. We had only 6 cars present; the 'Y's of Geoff Dee, Geoff Salminen, Ian Hawley, Derek Birch and Ron Kendall, plus my 'CX' tourer. Geoff Salminen had brought period gear for the 1930's picnic theme to make our stand a little different.



The two Geoffs (Salminen and Dee), plus Ron Kendall in period costume on the Y&C Register stand at Gaydon.

International correspondence

Flying the flag in Western Australia

In the August 2006 issue of 'Enfomation', the newsletter of the Classic English Ford Club of Western Australia, there is a lovely write-up on an event listed in the previous issue as a 'Garage Crawl'. To explain it, the write-up starts, "A lot has been written about blokes and their sheds (caves into which to retreat when danger threatens – like in-laws visiting or washing up!) so it was little surprise that 11 blokes turned up to look into other blokes sheds."

The first shed was 'doozy', which I gather is an Aussie term for 'spotless', in which was a sidevalve engined Dellow. The blokes then headed off to Ross's cave for morning tea. "What a great shed that is. Clearly he has a lot of fun in there, beer signs everywhere and his two 10/10s under restoration. From there round to Mick Cooper's 'studio' where he creates magnificent motors. The artwork that has gone into his Super 'C' has to be seen to be believed. It has taken a great deal of imagination to stretch several pieces of rusted out Model 'CX' wrecks to create this masterpiece."

The final trip (in their sidevalves) was to 'Derrick's place', after which there was a barbecue. Being a small club centred around Perth, this sort of event is easy to run and great for the members.

The Gaydon Motor Heritage Centre is well worth a visit at any time and entrants had a free entry pass to the vast range of superb exhibits – which includes WP 4335, the very original 1933 short rad Model ‘Y’ featured on our website. This car was once owned by the late Tom Morgan; one of our founder members.

The late Tom Morgan’s pretty original August 1933 short rad (apart from the early Ford Y&C Register grille badge!) on permanent display at the Gaydon Motor Heritage Centre.

The show was disappointing in respect of the lack of older Fords – no Model Ts or As and with the earliest post-war car being a prize winning 1962 Ford Classic. Visitors showed much interest in our early cars, but missed out on the vast range of 1940s & 1950s models from the important years in the development of Ford in Europe.

Ron Kendall’s April 1937 Tudor Model ‘Y’ was chosen as one of the 3 cars of the show, to his great pride. Another awards went to the 1962 Ford Classic and top award to a 2001 Ford Focus ST.

Ron Kendall’s Tudor Model ‘Y’ lines up with the other two prize winners at Gaydon.”

A good day – try to be there next year to fly our flag.

Bob Wilkinson.

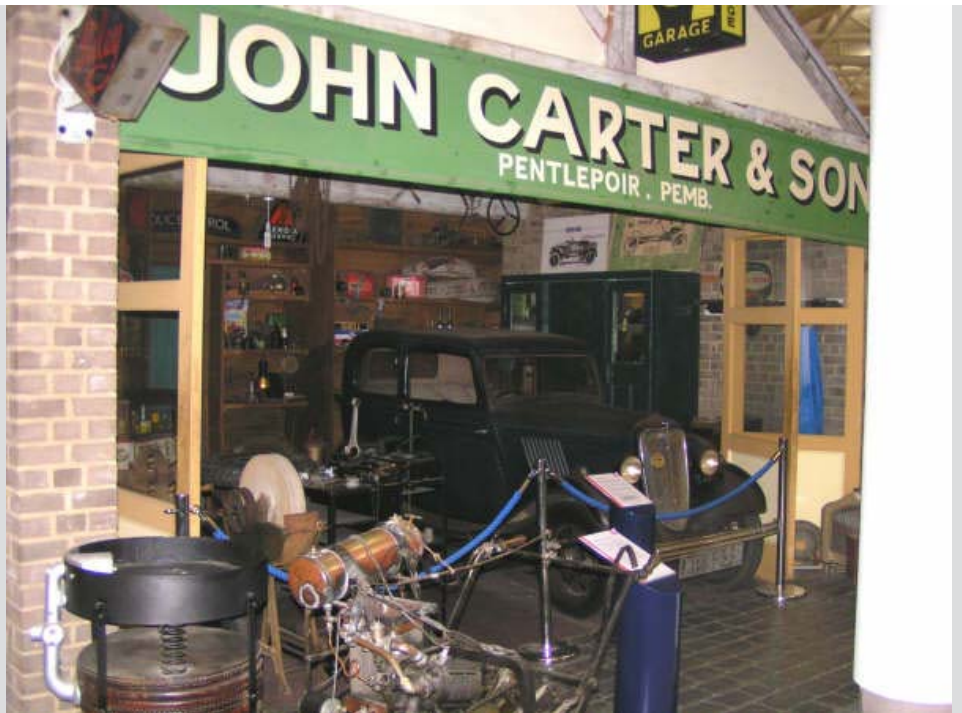

The accompanying photograph was one of many, taken in each of the ‘sheds’, accompanying the article. In the photograph, I was pleasantly surprised to see one of their members, Chris Newman, wearing an old Ford Y&C Model Register sweatshirt, which he purchased on his visit to England many years ago. Chris has recently been elected to be the Club Secretary, having carried the Editor’s mantle for a few years. [You see, Clubs do change Editors!!].

The blokes gather in Ross Whitfield’s shed for morning tea, although Ross, on the right, appears to be drinking his out of a ‘stubby’. The tall bloke, half-left, is Chris Newman, attired in a Y&C Register sweatshirt.

France

Having seen the article on Michel Aubry at the ‘Pique-nique des Années 30’, Paul Tritton, who has written a couple of articles in ‘Transverse Torque’ on his French exploits was moved to write:- “I was interested to

read about the French ‘picnic’ near Tours. In my first article, I listed four of the rarer makes of French car during my stay in that city.

Others that I saw or was familiar with were, Amilcar, Berliet (cars), Bugatti, Chenard-Walcker, De Dion (municipal vehicles), Donnet, Delage, Delahaye, George Irat, Licorne, Lorraine Deitrich, Hotchkiss, Mathis and Matford, Mochet (a cyclecar), Panhard,

Rolland-Pilain (the local make), Rosengart and Supertraction, Salmson, Talbot, Unic and Voisin.

Perhaps the picnickers will remember them. However, such is the decimation of the French motor industry!”

Queensland feedback

Brian Shields of the 8 & 10 hp Sidevalve Club of Queensland comments on my slightly disparaging assessment of his father’s attempts at climbing the Rosedale Bank summit in Yorkshire when he was but a lad in 1950.

“Thank you for continuing to promote our new club through your own magazine and the publication of our UK contact Brian Shields senior’s “experience” at Rosedale Bank in 1950. To avoid the possibility of mis-interpretation, I would like to add to your comments by explaining the context in which the article was written. The “tale”



is one of a series of "lighthearted recollections" of "nigh-on sixty years past" and should not be taken as a motoring assessment of the 'Y' model Ford of which the author remains an avid admirer."

Knowing the family circumstances of the time, this particular example would not have been particularly well maintained and almost certainly suffered from worn steering assemblies, engine valves and clutch amongst other things! As did my own first sidevalve, an E493A Prefect, which I don't think would have survived Rosedale Bank either, unlike my current "preserved" Prefects which have undertaken 3000 mile trips across Australia without incident."

Denmark

After 20 years, she runs! "As can be seen from the Members' Cars article in this issue, in Denmark we have the unusual situation of two rare Copenhagen assembled Eifel cabrio-limousines belonging to two old friends, one of whom, Michael Deichmann, is a member of the Club. Further to the Members' Cars story, the two cars are now under the same roof, or so it would appear from the following e-mail from Michael:-



Michael Deichmann's two-tone green Model 'C' Cabrio-limousine being moved to Børge's garage.

"Last Thursday Børge and I drove to the garage I own in a suburb of Copenhagen, where my car has been stored since it was dismantled. We took it out in the sun for the first time in probably 18 - 20 years, put it on Børge's trailer and took it to his place in Udsholt, close to Rågeleje where I live for the time being. Now both cars are under the same roof. As a funny detail, on Monday I went to the garage to get my starting handle and, this afternoon, I have been driving a Ford Model 'C' for the first time in probably 20 years - not my own, but Børge's. And not far - 5

meters out of his workshop and 5 meters back in. I got it started for the first time in several years, but one problem was the old petrol in the tank - another was that at least one of the spark plugs did not seem to fire as it should (it only went on 3 cylinders). I did not have time today for a deeper investigation, but the engine sounded very good. Børge tells me that he had it overhauled some years ago - new pistons, some of the bearings etc., etc."

And later still, a further PS:-

"We have now driven many kilometers in Børge's 'C'-model - although we had problems starting it, it turned out that one of the spark plugs was a defect/bad one. I found the right plug in the toolbox under the bonnet and voila! It just hummed like a bee. We still have a problem with some of the electrics (I haven't spent time yet on that, but Børge has actually asked Jens Hemdrup to come and take a look). One thing struck me when driving it. As you know, I have now also a Ford T. I drive typically at 60 - 65 km/h in that when I go to work in it for example. Based on my memory, I had expected that I could go the "legal" 80 km/h in the Ford 'C' and was surprised to read the high number of revolutions at 60 km/h in the C.

I know I often drove 80 km/h in mine back then, but it might be that Børge has another ratio in the rear axle. Once we get the wiring fixed and I fine tune the brakes, Børge will most likely get it MoT'd and registered. It brought back a lot of good memories driving a C-model again."

Holland

In the first part of the write-up on the Y&C tour of Holland, I twisted the arm of Wim Hofstede to keep his promise to send me one of the large posters we saw on the wall of the huge shed housing the private commercial vehicle collection which we visited.

True to his word, the almost four feet by three feet poster arrived at my door showing the 93

different Ford cars assembled and manufactured by Ford of Holland over the 75 years 1924 - 1999, from the Model T to the Ford Cougar.

The reason I was keen to have one of these posters for the archive was because of two cars in particular. I illustrate them here and ask the more knowledgeable of you to comment. Over the period of production of our cars, five cars are illustrated on the poster; B-Ford 1932 - 1934, Y-Ford 1933 - 1936, C-Ford 1933 - 1936, Ford V8 1935 - 1936 and Ford "Vier" 1935 - 1939. The two cars I want you to comment on are the C-Ford and the Ford "Vier".

I believe the Ford Motor Company of Holland have made an error and have referred to the 1933 - 1934 V8 Model 40 as the C-Model and omitted the C-Model 1934 -1937 - our Model 'C'/'CX' - from the poster.

The name Ford "Vier" given to the later Cologne manufactured Ford Eifel is a new one on me. I am aware that the Ford Eifel was sometimes called the Ford Junior De Luxe in Scandinavia and could well have been given a more Dutch name in Holland. I am assuming that 'vier' means 'four' in Dutch, referring to the number of cylinders. Has anyone come across the name Ford "Vier" before?

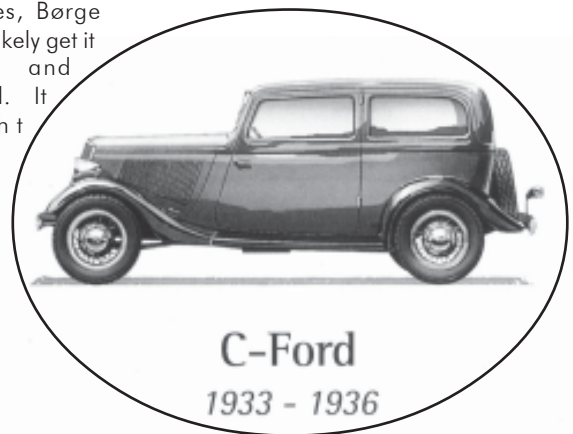

The illustration of the C-Ford on the 75th Ford of Holland anniversary poster.

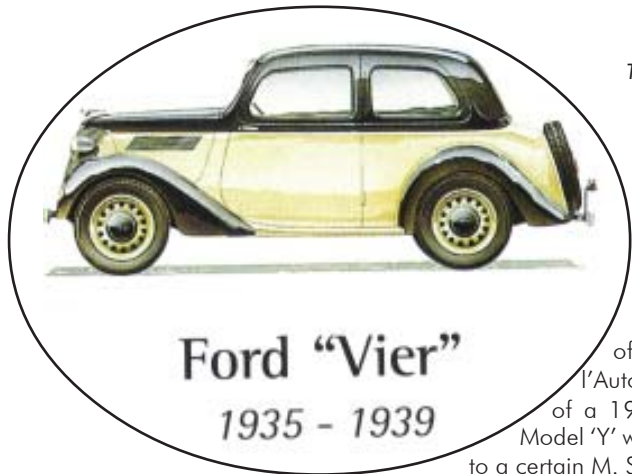

Ford "Vier"
1935 - 1939

The Ford "Vier" as illustrated, which is identical to Jim Miles' Eifel saloon. Illustrations with thanks to Wim Hofstede.

France from Spain!

Luis Cascante has been brushing up his French lately. He e-mails, "In an old issue – February 1987 – of the French magazine *La Vie de l'Auto*, I found the attached photograph of a 1932, 4 door, Asnières assembled Model 'Y' with a big boot fitted, then belonging to a certain M. Sabot. I will send a reproduction of

the complete article in a next e-mail. [Unfortunately, the photograph of M. Sabot's car is too indistinct to reproduce. In translating the French article, I noticed that the author comments that the Model 'Y' was a copy of the 'plus grosse "V8-40" américaine', whereas we all know that the American V8 Model 40 was a copy of the Model 'Y' – don't we? However, as the article was written in 1987, we will forgive the author.]

About the Asnières Model Ys, some years ago I sent you another photograph of a Model Y spotted in the Rue de Rivoli of Paris in 1954, beside a laboratory car christened 'Genevieve', a SIMCA Aronde. Unfortunately, the photograph was too dark to be printed. Perhaps it can be reproduced now, with the new improvements in the magazine printing, together with your skills



The 'too dark' photograph of the Asnières assembled Model 'Y' trundling down the Rue de Rivoli in Paris in 1954.

with the computer. I am sending again the photograph in another e-mail. Curiously, lately I am finding more photographs of the French than the Spanish Model Ys!

Luis, bless him, tried to understand Ron Kendall's article in the last issue on fitting a ballast resistor to the coil., which I rather cruelly titled 'Technical or what?' (I also referred to Ron as Roy – I apologise for

Australia

both indiscretions!). Luis writes, "In the last issue of *Transverse Torque*, Ron Kendall wrote a technical article explaining how to improve the ignition during the starting of the engine. I am not sure to have understood the idea. Perhaps Ron can send a wiring diagram of the modification he has introduced to his car, for a better comprehension." – Over to you Ron.

Because Australia had punitive luxury goods (including cars) import duties following the First World War, which spawned a whole new coachbuilding industry across the continent to build bodies to go on to imported non-luxury rolling chassis, a wide range of body styles became the

norm in Australia. The Ford Motor Company even had its own body-building factory (Ford Manufacturing Company of Australia, Pty., Ltd.) co-located in Geelong and its own body designer in the form of the great Lew Bandt.

However, watch this space. 2007 is the 75th anniversary of the launch of the Model 'Y' and, as you will have read in 'Transverse Torque', we are trying to get together in one field at Stanford Hall, 75 of our cars. What that might throw up in the way of records, we shall see."

Bill has responded saying, quite rightly, that it is possible to have more than five 'C's'/'CX's' of differing body styles in the UK, i.e. Tudor and Fordor 'C' and 'CX' and the 'C' and 'CX' tourers! We will see what we can achieve next year.

France again.

Michel Aubry rose to the challenge in the last issue to provide a photograph of the engine compartment of his Asnières assembled short rad Model 'Y' to compare it with the photograph found by Luis Cascante in the French magazine, 'Automobilia', which purported to show the engine compartment of a French short rad. Luis asked whether the coil was fixed in a horizontal position on the bulkhead in production and if the tool box extended the width of the scuttle as seemed apparent in the 'Automobilia' photograph.

Michel Aubry's photograph (he sent in six, taken from different angles!) is shown alongside Luis' and makes Luis and me look rather silly! The first point to note is that the coil is vertical in the centre of the bulkhead. Michel has a second coil where the oil can holder is on Luis' photograph. From the slightly elevated angle of Michel's photograph, we can see that the extended tool box lid is an optical illusion on Luis' photograph. Of course there would be a battery in the normal place but it is either missing or a squat one! The one major tell-tale difference between the two photographs is that we can see the steering column on Michel's left hand drive car and that it is conspicuously absent on the 'Automobilia' photograph, pointing to that one being a Dagenham built right hand drive car!

Incidentally, Michel points out that he has fitted a temperature gauge for his cooling system. He explains, "You will see on the photo a small hose on the big water hose to the radiator; it's a recent modification. The small hose goes to the "dash board" to control the temperature of water. It is a security measure..."

Thanks Michel and Luis for the photographs. We seem to have cleared up an anomaly that didn't exist!

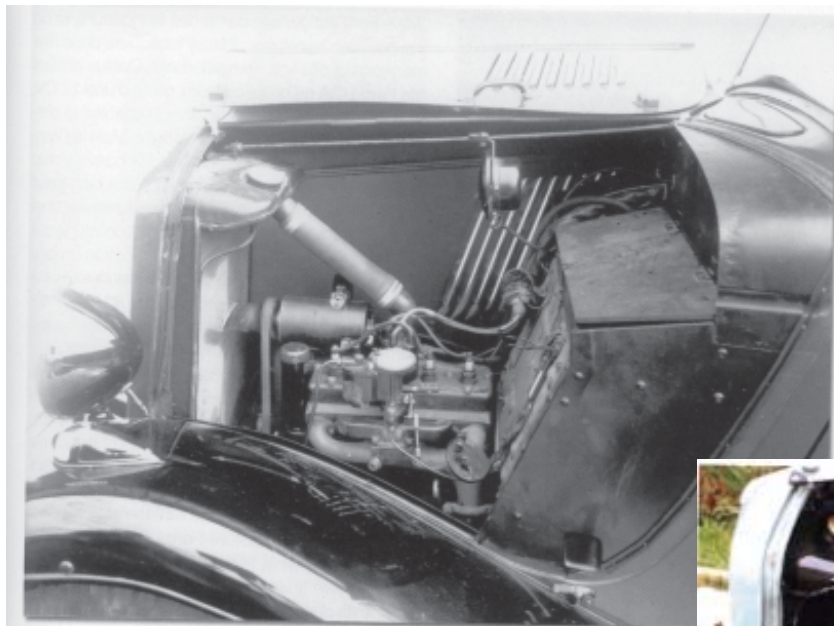

Left: The 'Automobilia' photograph, showing an oil can holder where the steering column would pass through the bulkhead."

Below: The engine compartment of Michel Aubry's LHD Asnières assembled short rad. Note the steering column.



FBHVC News.

The following is from the latest FBHVC Newsletter - by Sandy Hamilton

Age-related replacement registration marks

Age-related registration marks are issued to pre-1963 vehicles either upon first registration (imports) or, more usually, when the original mark is sold or transferred to another vehicle. The volume of stripping marks for sale has resulted in exhaustion of the current series of UXA-UXY in the reverse format (e.g. xxx UXT) after a relatively short period. The replacement series will continue the reverse format and will be xxx XUA to xxx XUY.

For some years the replacement marks for pre-1930 vehicles have been in a 'two letter, four number' format and issued from the DS range. This has become exhausted and marks will now be issued from the BF range, which has previously been un-issued (with a few exceptions). The letters BF were allocated to Dorset in 1904 under the compulsory registration procedures introduced by the Motor Car Act of 1903, but local motorists objected and it was withdrawn. Apparently it was deemed to be offensive and motorists were offered the opportunity to exchange their number for a replacement in the FX range. Another mark to fall foul of the morality police was WC; however, VD was allocated to Lanarkshire and FU to the Lindsey district of Lincolnshire, so those guardians of early twentieth century morality may have led rather sheltered lives. How times change!

The second paragraph relates to cars older than our 'Y' & 'C' Models, but I include it here for amusement as well as for information! As usual, may I remind members requiring information on registering their 'Y' or 'C' Model please contact me or download the information from our website.

Bob Wilkinson. Secretary.

All Ford Rally

The Y&C Register stand this year was probably the most interesting one ever for the pre-war small Ford enthusiast. Never have we seen such a variety of body styles in our line-up of 22 vehicles. The star of the show and the vehicle voted by the vast majority of members present the 'Best of Show' and winner of the Bert Thomas salver was Jim Miles' recent acquisition, a German Ford Eifel roadster. This is the Eifel we found on our tour of Holland, residing in the back workshop area of the den Hartogh Ford Museum in Hillegom. In our defence, the lighting in the workshop was not good and the cars were packed in there like sardines, so we can be excused for thinking we had come across an Eifel cabrio-limousine. I reported it as such in the write-up of the Holland trip. But there, in the open air and sunlight of the All Ford Rally on Abingdon airfield, the attractive lines of the roadster were obvious; the beautiful sloping beetle back and the dip on the top of the doors for the elbow and forearm to rest made it look very graceful.

At the All Ford Rally our cars fall into the Class 2 category, which covers Fords made between 1932 - 1941 and includes, not only the 7Y, 7W and the early Anglia and Prefects of the Sidevalve Club, but the Model B and all the super V8s of the 1930s. Despite that, our cars walked away with first, second and third prizes in the class. All three winners were Model 'Y's. The first prize went to the most unusual Model 'Y' saloon present; Ken Wilding's lovely green and black December 1936 Fordor with a period boot. The boot was made by Galley Ltd. of 115 - 129 Carlton Vale, Maida Vale, London NW6. Under the manufacturer's plaque inside the boot is hand-stamped 60 and F8, in line with the blank Serial No: and Type: sections of the



The graceful lines of the recently acquired Eifel roadster, which won the Bert Thomas, 'Best of Show' award for Jim Miles.

plaque, so perhaps this was the 60th boot of this (Model 'Y' (F8)?) type to have been manufactured. Soon after the car arrived from Hadleigh in the wilds of Suffolk, and while we were still ooh-ing and ah-ing over it, son Richard was busy with the elbow grease bringing the paintwork and chrome up to its full potential – put us all to shame really. However, the judges obviously appreciated it – well done both of you.

The manufacturer's plaque inside the boot of Ken Wilding's Fordor Model 'Y', showing the 60 F8 hand-stamp under the plaque.

Ken Wilding's Fordor with the period Galley boot. This car won first prize overall in Class 2.



The second prize went to Dave Perks from Stourbridge in the West Midlands with his gleaming black March 1937 Fordor, which he restored fully four years ago and which is soon to be the subject of Members' Cars in

the magazine. Again, a well-deserved winner and one happy bunny, who made a round trip of 300 miles to be there.

The third prize brought a whoop of delight from Phil Francis, when he was told. Phil is a local from Witney in Oxfordshire, who owns a very smart green March 1936 Tudor with a very low mileage. I'm sure his trophy will be treasured and will have pride of place in his "bull-shit corner" at home. Well done Phil.

But they were only the prize-winners. There were two Model 'CX' tourers we had not seen at the rally before; Peter Baggott's light green car from Sandwich in Kent and the newly restored dark green beauty of Bob Wilkinson, shown on the front of this issue. Overwhelmingly, Bob's car was voted as the 'Best Restoration' and won the Eric Bufton trophy. Being our Secretary, he had to make a good job of the restoration and the perfection shines through! (It's even smarter than our Chairman's 'CX' tourer – or so the lads tell me!)

The trio from Sussex, Julian Janicki, Tony Hurst and Frank Gowing drove up in David's yellow March 1933 Cairn Coupé, a short rad Model 'Y' bodied by Salmons & Sons and with a Tickford hood. Each seemed to be taking it in turn to drive. We last saw the Cairn in the car park by the Dunbrody replica emigrant ship in New Ross harbour on the round Ireland tour in 2002. Before then, it was last seen in John Harrison's ownership at Stanford Hall in June 1988. John had driven it down from Scotland for the event. I'm sure we shall see more of it in the future.

Three Model 'Y' tourers were present; David and Wendy Grace's Alpine, Graham Miles' Knibbs-Parkyn and my Kerry, which was parked alongside Tim Brandon's very unusual ex van, Model 'Y' pick-up. This, with John and Jim Murray's green Model 'Y' van gave a commercial



touch to the display. The annual thoroughbred 'regulars' were present, spiced with the rare electric blue paintwork of Tony Brasher's 1934 Tudor 'Y', Kevin Briggingshaw's ever-attractive maroon short rad, the rarely seen two-tone brown job of Godfrey Dingley-Jones and Rod Janes re-registered Tudor

'Y', giving the small-Ford fans and the judges a feast for the sore eyes. Another vehicle present was a three wheeler trailer which transported the Grace's three-legged dog, Ben, around the stand. That is until the temptation became too much for Wendy, who then filled the Alpine with shrubs and plants making it look like something from Kew Gardens!

As was said at our little prize-giving ceremony and, incidentally, also by 'Spanner' on the rally Tannoy system, each year the quality of the cars present increases as we members, as temporary custodians of the old ladies, gradually add to the state of the vehicles as we find them. That of course is in direct keeping with the aims of the Ford Y&C Model Register.

It was great to see so many members and the wives and partners at the rally, some without their cars, for whatever reason. The next big gathering is the celebration at Stanford Hall on **Sunday, 24th June 2007** to mark the 75th anniversary of the introduction of the Model 'Y'. We need you all on

that day to achieve an all-time record of at least 75 of our vehicles in one place, even if they have to be trailered! (see photo on next page).

Sam Roberts (and Paula came too!)



Frank Gowing's rare Salmons & Sons bodied Model 'Y' Cairn coupé, driven up from West Sussex with Tony Hurst and Julian Janicki also on board."

Region 5 - East Sussex & Kent

John Keenan reports:- "At the end of the London Parade Jim Sharpe and I missed the group photograph because we did not know where to meet?!? I have enjoyed some very good car shows and the most enjoyable tour of Holland this year. We do have the main event at Stanford Hall in June to look forward to next year and I hope to see everyone there.

Christmas dinner

We are booked into the Green Man, Ringmer, Nr Lewis, East Sussex for a Christmas Dinner on Thursday 7th December. The cost has gone down to £15.95 this year so, any one interested in joining us, just give me a call (01424 424323).

Thank you Sam for producing our very fine magazine and I hope you and all my other friends in the Y & C club have a most enjoyable Christmas and a prosperous New Year. All the best.

Mary and John Keenan."

Regional news

Region 2 - The West Country

An anonymous donor sent me three photographs of our cars at the Great Dorset Steam Fair in early September. His comment on the back of one photograph was "Not very good this year. Got round in 5 hours." One photograph was of Peter Baggott's smart 'CX' tourer and Ian Moss's trials Model 'Y', another of Philip Wookey's Model 'Y', the photograph of which I have included in the '20 years ago' article in this issue, and the third photograph was of David Loverings old car, a black Fordor Model 'Y', CYH 780, which now belongs to new member, Mervyn Fox. I believe the

anonymous donor of the photographs could be Phil Wookey, as that is the only photograph without a comment on it.

Peter Baggott's green Model 'CX' tourer, a long way from its home in Sandwich, Kent, alongside Ian Moss's trials Model 'Y' at the Great Dorset Steam Fair."



The smart looking Fordor Model 'Y' at the Great Dorset Steam Fair belonging to new member, Mervyn Fox.



Region 13 - Norfolk and Suffolk - Brian Mace reporting.

First of all, on behalf of all the members of the Norfolk and Suffolk Y&C Register, a big thank you to **Renier Dubach** for the DVD of our wonderful trip to Holland. It was very unexpected.

Police Gala Day

Sunday, 3rd September was the Police Gala Day and BBC old car rally here in Norwich. We had five Model 'Y's on show amongst the 450 cars, buses and motorcycles present. The BBC Radio Norfolk old car rally happened almost by accident after a chance remark on air resulted in many listeners writing in about the much-loved classic cars. The first rally in 1981 attracted just 100 cars. One year, a record 28,000 people attended. Over the years, the Y&C Model Register has done well; I won a cup with a cheque in 1994 and Nick Smith did the same in 2004.

Those attending this year were: Nick and Monique Smith, Noel Page and James Birch, Tim Brandon and Glynis, Dennis and Jean Warner and Yvonne and myself.



The Y&C Register stand at the Norfolk Police Gala Day and BBC Radio Norfolk Classic Car Rally in September. Holding up the Y&C Register flag is Brian Mace's Tudor 'Y', then Nick and Monique's and Noel Page's black Tudors, Tim Brandon's Orient blue Fordor and Dennis Warner's maroon Tudor.

1940s Weekend; North Norfolk Railway

The 1940s weekend at the North Norfolk Railway went off very well, with seven Model 'Y's on show, which was one up on last year, thanks to Jim and Joan Sharpe. There was room for a Model 'CX' tourer and I was looking forward to seeing Bob Wilkinson in my part of the world. Perhaps another day!

I am pleased to say that members of the Register, families and friends all dressed up in the style of the '40s. The highlight of the day was the steam engine, which was brought to this country from the U.S.A. in 1945 to pull US Army equipment on the south coast. It was operated by the U.S. Army Transportation Corp. In 1947, it was sold to Egypt, then on to China. In August of this year, it found its way to Norfolk.

At 3.30 p.m. at Holt station, my party and I decided to catch the last train down to Sheringham. At Weybourne the train had a problem, so they put on another engine to take us down to



Looking like a group of refugees from World War II, the Norfolk group (with a smattering of Cambridgeshire and Essex) enjoy the 1940s Day on the North Norfolk Railway. Photograph courtesy Tim Brandon.

to Sheringham. They then realised that the engine was not powerful enough to take us back to Holt, so they put on a diesel as well as the steam engine. The train was packed and it was all good fun. We arrived at Holt station to find that the other 'Y's had gone. By the time we had our fish and chips tea, the light was going fast so, with 25 miles to go on 6 volt lights in the dark, we ended a day of good fun.

Those present were Nick and Monique Smith, Roger and Jo Hanslip, Jim and Joan Sharpe, Noel Page, Tim Brandon and Glynis, Dennis and Jean Warner and Brian and Yvonne Mace and Brian's sister.

NORTHERN SIDELIGHTS - Region 16 - Yorkshire less South Riding. Barry Diggle reports:-

My 1936 Tudor Model 'Y', CNN, has put in an attendance at two local events since the last issue. Otley Vintage Vehicle Extravaganza was chosen as a nearby event in lieu of the traditional Bradford-Morecambe Run, and the Bolton Abbey Station event in very early October offered a good mixture of steam and internal combustion. Apart from a few later sidevalves there were no other cars of our particular fancy.

In the current issue of 'The Automobile', David Royle, of the much-respected and old-established firm of Vintage Car Specialists at Staindrop in Darlington, writes about the future decline of skills necessary for the continued restoration and maintenance of old motor cars. He speaks about the skill shortage, which is even recognised by the government, and the decline of traditional apprenticeships.

It occurred to me, whilst discussing the outcome of an MoT on my other old car, that increasingly the number of mechanics testing these cars have little or no experience of them. The mechanic in question, whose skills with more modern motors are excellent, did have some difficulty in identifying the correct name of the component in question, notably the front radius arms. Of course, to be realistic, we can't really expect the average garage to show the same enthusiasm for the historic motor that we do.

David Royle makes a good point, though. Being involved in post-16 education, I see hundreds of students opting for Business Studies, Law, ITC, etc., with only a tiny handful considering a career in anything vaguely craft-based. Whilst lower down the school, traditional metalwork and woodwork courses have been replaced by subjects concentrating more on design and packaging rather than traditional practical skills. With the manufacturing base now moving more towards the Far East, there are some very

complex issues involved, clearly beyond the scope of our organisation.

However, now that winter is imminent, I would be delighted to hear about any restorations that are ongoing in and around Region 16 so that I can make some mention of them in future 'Sidelights'.

Region 19 – Ireland

Craig Toomey writes, "I came across a 'Y' based special at the Ford and Fordson Show held at the Cork Showground in the Republic of Ireland, on 3-4th of April. I took my Model 'Y' along and was parked next to the Millpool Special, ZA 8523, owned by Denis Walsh. It's based on a Model 1936, chassis no. Y 102969, using a 10 hp engine. The Morris radiator is to help cool the engine only. Denis has owned it for around 40 years and still races and hill climbs it. It attracted a lot of attention at the show, reflecting the general Irish interest in motor sport and rallying.

On 28 May I went along to another local show, which turned out to have an amazing collection of cars and bikes, equally as good as any show that I've attended in England. At the show I met Flan O'Meara with his four-door.

The beauty of the shows over here is that they are generally in aid of a local charity and not a money-making event for an individual.

Spares report

In the last magazine I told you that Colin Rowe was taking over the Parts Administration job. You obviously read the article as I have only received one order since the end of August, and Colin has had lots. I must admit we were expecting some confusion but thanks to you Club members the changeover has gone very smoothly. Colin describes his job spec in the next article.

On another subject, we don't only have the items listed in the 'Parts for Sale' page in the magazine, these are just the more popular parts. There are lots more things that we may be able to help you with, some "new" old stock or secondhand. Those of you who go to autojumbles know that finding parts for our cars is getting very difficult. What you may not know is that people like Graham Miles, Jim Miles and Kevin Briginshaw, to name a few, spent years trawling autojumbles and trade shows to collect useful parts for the Club. You may be surprised at what we have to offer.

Exhaust Systems

We seem to have been talking about this for ages but we now have some good news. In this issue of the magazine we are listing a heavy duty steel system for the Model 'Y' at £100. The one I test-fitted to my car worked well and was simple to install; the thickness of steel used should see the system last for many years. It comes in three pieces and includes fixing clamps, as you can see from the photograph. The kit consists of a front pipe, muffler and extension pipe. This is the standard



The Ford & Fordson Show held at the Cork Showground. Craig Toomey's beautiful blue and black Model 'Y' sits alongside Denis Walsh's Millpool Special, which is built on a Model 'Y' chassis and has a 10 hp Model 'C' engine."

Flan O'Meara's smart Fordor Model 'Y' at a local show near Cork at the end of May.



system for the 'Y' with the outlet finishing by the nearside rear wheel.

We are still looking at a similar system in stainless steel, but this will be much more expensive. The only consolation is that your grandchildren may have to rebuild the rest of the car, but the exhaust should still be serviceable.

Other news

We are now able to supply, through Dave Tebb (01937 557410), fuel tanks for both the Model 'Y' and the Models 'C'/'CX'. Both types have been trial fitted to cars and proved satisfactory. If you have a leaky tank, there is no safe substitute for a new one. If you don't believe me, ask your local man for an estimate to repair your old tank; that's if he's prepared to work on it.



The new heavy duty steel Model 'Y' exhaust on sale to club members.

New rear lamp brackets for your 'C'/'CX' can also be obtained from Dave Tebb. Contact him on the same number.

One last thought, Christmas is coming so spare a thought for the old girl in the garage or workshop (I'm talking about the car, ladies) and give her a treat this year, be it a new shiny bit or something practical to keep her running sweetly.

Having broached the subject, whatever you do, don't forget the Wife's present! [A new shiny bit or something practical to keep her running sweetly? – Ed]

**Happy Christmas
and a Prosperous New Year**

Jim Sharpe, Spares Secretary

SPARES ADMINISTRATION by Colin Rowe

Some History

Back in issue 144 (Sept/Oct 2003) Jim Sharpe reported details of a "New Spares" organisation for the Club. Prior to this, spares had been mainly the responsibility of the hitherto Spares Secretary, Graham Miles, a daunting task for one man to undertake – obtaining, storing and distributing stock items. In the summer of 2003, a reorganisation of the spares

operation meant that the available items printed in each edition of 'Transverse Torque' were divided among six volunteer "Spares Holders" around the country, under the headings of:- Engine Parts, Shiny Bits, Transmission, Brakes, etc.

I volunteered at the AGM in 2003 to become a spares holder and remain as such – an activity I thoroughly enjoy. At the AGM in 2006, it was announced that Graham Miles, Spares Secretary, would not seek re-election. Jim Sharpe offered to take over the position from him. At this point Bob Wilkinson suggested that I took over Jim Sharpe's position as Spares Administrator, as an extension to my spares holding role. This I accepted, taking over the position on September 1st 2006.

Nothing has really changed

Jim Sharpe reported in Issue 162 (Sept/Oct 2006) that after 4 years he was glad to hand over the "Stores Department". All that has changed is where you - the members – send your orders. The Issue 162 order form shows the new administration address of the club. Unfortunately my email address is incorrect on the form, as is my mobile phone number on the inside cover of the magazine. These have now been amended as follows:

Email: ColinJRowe15@aol.com
Mobile: 07944 825045
In addition you can fax to 01327 359772.

My intention is to offer a high level of commitment to servicing members' spares requirements. I will guarantee to continue to respond to orders efficiently and promptly in the manner that members had become accustomed to under Jim Sharpe.

A few reminders

Please remember that the Club is run by volunteers who undertake all work for the club in their spare time. For this reason I would like to ask for your patience once an order has been placed. You can be assured however that every effort will be made to supply stock spares as quickly as possible.

All the instructions you require to order parts are on the form stapled into the centre of each edition of 'Transverse Torque'. To avoid errors I will only accept written orders on this form. It should either be posted or faxed or, for the "IT literate", scanned and emailed as an attachment. All details on the form should be completed. **Remember, if you have not paid your subscriptions for the current year, no parts will be supplied.** Payment by cheque or credit card will be accepted and I guarantee that cheques will not be cashed or credit/debit card details processed until the goods are shipped. Can't say fairer than that!

Finally, where exchanged parts are involved, to ensure recycling and maintenance of availability for other members, these should be returned to the correct address promptly. This information will be given to you at the time of ordering and you should return your old part before the replacement is despatched.

Many thanks. "To serve you is my duty – to serve you well is my pleasure"

**Colin Rowe MIMI
Spares Administrator**

Tappets

I am grateful to Denis Johnson of the Western Australia Classic English Ford Club and Chris Newman, the ex-Editor of their magazine *Enfomation*, for the following contribution:-

Denis first:- "I've rebuilt and tuned quite a few Ford engines in my time and had come to accept noisy tappets as a fact of life caused by worn valve guides and tired valve springs. One culprit I hadn't considered until recently was the tappet itself. Nothing much could go wrong with them I supposed, it being just a metal cylinder, albeit hard faced at both ends.

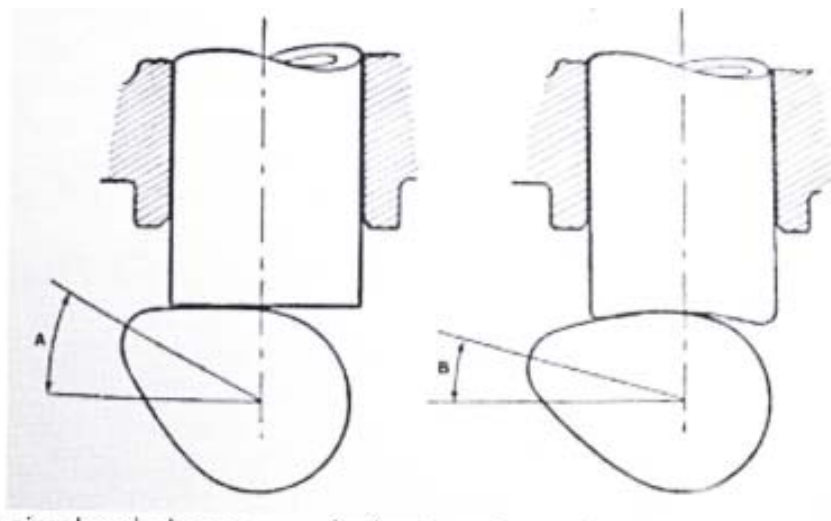

But I was mistaken. Recently faced with a valve seat clean-up, I realised I was getting close to needing valve seat inserts because I could no longer take any metal off the valve to allow for clearance. (If you take too much the spring retainer protrudes below the end of the valve foot and it is that which hits the tappet first and not the valve stem). Also when measuring the clearance you get a false reading.

The 'mechanic' suggested that take a few thou (thousands of an inch) of the tappet face instead of the valve for. The technical term for this is a "no-no". even if the exhaust tappet is four thou shorter than the inlet, the hard facing is probably only 10 – 12 thou thick. Also a short tappet can't be made long again but an engine block can always have valve seat inserts installed or new valves can be obtained. But at what cost and how many miles are you going to do with that engine in your life time anyway.

So I was persuaded to lop off a few thou from each tappet. What a revelation! Of the eight, four were essentially flat topped to start with, but four were not and the removal of 2 – 3 thou still didn't cut out the dish pounded into the tappet after 50 years intermittent use. Some tappet tops were dished up to 6 – 8 thou deep! When you put a feeler gauge over the top of the tappet to set the clearance, it bridges this gap and touches the spring retainer so the reading is meaningless. An 11.5 thou reading could actually be 18 thou. Hence the noise and poor performance. You learn something every day!"

Chris Newman, as Editor, chips in his penny'th:-

"However, Denis, although the removal of metal from the tappets is normally considered a "no-no", it is an option if you want to get more torque out of your motor at high revs. From the book, 'The Ford 10 Competition Engine', by P.H. Smith, he shows a way that you can use to obtain longer valve opening and increasing the speed of the 'CX'.

You simply grind a concave in the tappets as shown on the right in the diagram, to hold the valves open longer. He also states that you can build up the ends of the valves to achieve the same result, but this has its limitations."

The 2006 Powerscourt Estate Picnic Run

The 29th year of this popular event.....

Despite an expected forecast for a cold and damp day, spirits remained high for the 2006 Powerscourt Estate Picnic Run. As the day progressed, the weather became one of the stars of the day, turning out to provide one of the most beautiful days of the year. The sun shone brightly and the temperatures soared on what turned out to be one of the most successful runs that Powerscourt and the Irish Veteran and Vintage Car Club have hosted.

Again this year, we saw a high number of entries, with 138 cars present at Powerscourt on the day. Due to the majority of drivers availing of pre-registration and the fact that it makes planning this event easier and therefore more successful, it has been decided that for the 30th anniversary of the picnic run next year, 2007, only pre-registration will be accepted and that the number of cars will be capped at 140. This should allow for an even better experience for all concerned. In light of the forthcoming 30th anniversary, all drivers will receive a commemorative plaque to mark the occasion.

And They're Off.....

The annual starting venue remained unchanged in Airfield. With no sign of the threatened bad weather the cars looked their very best for their big day out. The excitement of all the gathering drivers and passengers was palpable, the pride of owners written across their faces, like parents as their child's first play.

Again, many thanks must be extended to Michael Duff and Bernadette Wyer, who's Trojan work ensured an organised and well run reception for all at Airfield and without whom this years rally wouldn't have been the success it was. Along with Colm O'Neill and Club President Robin McCullagh, these stalwarts ensured the day went without a hitch. Thanks also to their support team, who saw that all the small details were in place so that the day was a happy and successful event for all.

Again this year, particular thanks goes to Frances Elliott and her team at Airfield as well.

.....Two Classes, Both Upper

The cars made their way to Powerscourt incident free, a slow steady procession of some of the finest cars built since cars first appeared on Irish roads. Many onlookers took advantage of the sunshine and waved to the drivers as they passed on their way, to eventually arrive safely in Powerscourt. Following on from last years introduction of the segregation of the cars into the two classes, Pre-War and Post-War, the cars separated to their respective areas as they arrived. This change was very popular last year and again in 2006 everyone felt it enhanced the display of the cars at Powerscourt.



It Wasn't All About The Cars

The Powerscourt event is about more than just the cars, some might think of the cars as just an excuse for a great day out. St. George's brass band, (under the accomplished skills of Neville Bryan), provided the musical accompaniment to the complimentary wine that was very generously provided by Powerscourt and the Slazenger family. And many thanks are extended to Thomas, the barman, for his very capable help. Also a special mention and thanks must be extended to Carmel Byrne for her sterling help in organising the events at the Powerscourt end.

With the (unexpectedly) terrific weather, all present took part in the atmosphere, the picnics were rolled out on the grounds and the sounds of music, banter and children running about could be heard throughout the event, as the judging took place. A presentation was made to Bridget Greaves of a gift of Belgian chocolates in appreciation of all her unflinching work for the event, on behalf of the I.V.V.C.C..

John Fitzgerald and Joe Duigan's Model Y's on the Powerscourt Picnic in front of the Y&C Register flag.

Finally I wish to thank everyone who attended and I hope to see you all again next year for the 30th anniversary Picnic Run. I have no doubt that it will be a particularly special event.

John Fitzgerald, Regional Contact - Ireland

P.S. Shortly after the Powerscourt run, Fred and Jenny Hooper, who provided the splendid barbecue at their house in Christchurch on the Convoy 2000 rally, called in to see John and Lillian at their house in Stepaside, Co. Dublin.



Fred and Jenny Hooper meet up with John Fitzgerald (right) in Stepaside.

More Post Cards

We have two post cards in this issue showing off our cars; both from Brian Mace in Norwich. Brian and Yvonne love to pore through the cards at antique fairs. Brian says he has eight more showing our cars in their heyday. The cards range from 1938 to 1967. Brian is keen to show our overseas members what it was like when our cars were new or not too old.

A Model 'Y' is parked on the left of Chester High Street, probably around 1945. As Brian notes, the soldier in the bottom left hand corner is wearing a beret. He says, "As we all know, berets were not issued until 1943" – yes Brian! The roadway between the two gates in Chester is now pedestrianised.



A busy photograph of Market Jew Street in Penzance, Cornwall. The Model 'Y' is a Cornwall registered December 1936 Tudor "Popular" with, what appears to be, fixed orange direction indicators on the sides of the roof. The Hillman van behind has a 1950 London registration, which is the nearest we can get to dating the photograph.



Brake shoes and adjustable brake rod ends

I am grateful to the Ancient Ford Club of Belgium for reproducing in their newsletter the French 'Ford Service Bulletin' of 'mars - avril 1937', in which was spelt out the differing brake shoe stops fitted to our cars and the details of the greater length adjustable clevis end to the brake rods introduced in October 1936. This Bulletin was a repeat of the D a g e n h a m "Popular" and "De Luxe" Model Bulletin of Nov - Dec 1936. As it is of interest to those carrying out brake restoration or overhaul, I repeat it here:-

It is apparent from investigations made on a number of "Popular" and "De Luxe" model cars where defective braking has been experienced, that some dealers, when fitting reconditioned brake shoes, are neglecting the information given in the "Popular" and "De Luxe" Model Bulletin, Volume 4, number 6, regarding the correct pairing of brake replacement parts.

The trouble arises mainly through the matching of the early design brake shoe CE-2019-AR with the current type stud. At the operating end of the brake shoe a semi-circular stop is provided which rests against the wedge stud when the brakes are "off" and so determines the position for initial adjustment of the brake shoe.

The shank on the current type stud, however, is of greater diameter than that of the semi-circular stop on the early design brake shoe, so that if these two parts are used together the stop will not fit snugly round the stud shank but will ride high on the two extremities of the stop, as shown in Fig. 14. As a result the operating end of the shoe is held farther away from the stud and closer to the brake drum than should normally be the case when the stop is located against the shank of the appropriate stud.

As the operating end of the brake shoe is set close to the drum, resulting from the use of incorrect parts as shown, the adjusting wedge can only be taken up a few notches before the shoe starts to rub against the drum near the operating end. When the brake pedal is applied the wedge brings the operating end of the brake shoe closer to the drum while the

This movement of the wedge before the brakes are applied necessarily limits the available effective operating movement and may cause the wedge to move downwards to such an extent before the brakes are fully applied, that further application may result in the wedge scoring the brake drum.

When fitting new or reconditioned brake shoes to a brake housing plate it is most advisable to remove the brake operating wedge stud and try the ends of the shoes against the shank to ensure that the stops will bed down fully on the stud when assembled in the "off" position. If this does not occur, either the stud or the shoes should be changed to conform with the other part.

It should be noted that the part number of the current type stud with the larger

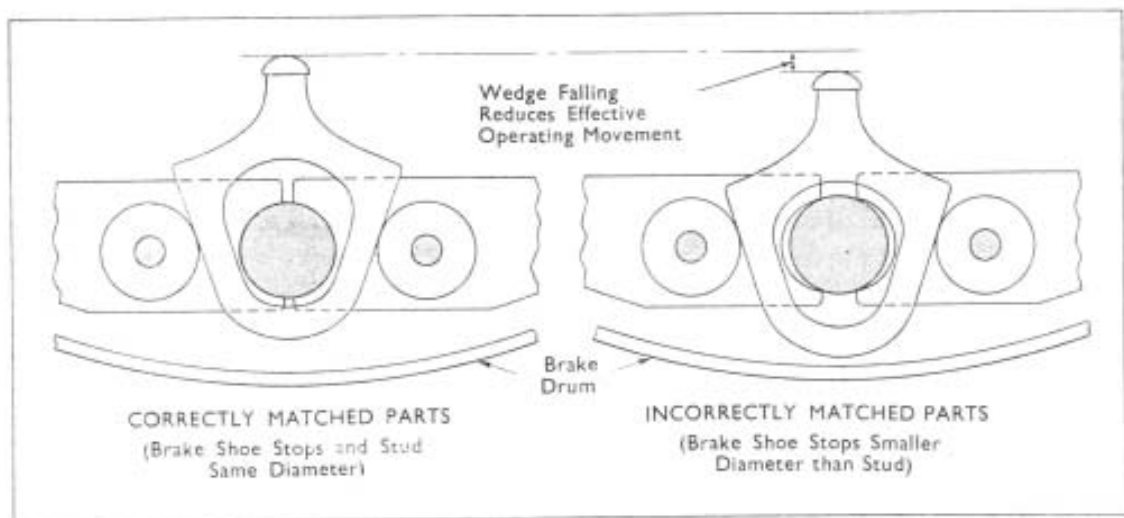

Fig. 14

adjusting end is barely touching. In this way the braking is unevenly distributed over the brake lining, rapid wear of the lining takes place at the operating end and very soon it will become impossible to adjust the brakes correctly unless the linings are renewed, as they no longer conform to the contour of the brake drum.

In addition, the shoes being held farther away from the stud at the initial setting, the brake shoe operating rollers are moved farther apart and the wedge drops an appreciable amount, as shown at the right of Fig. 14.

diameter shank (.687") has been changed to CE-2053 and the washer to CE-2054.

To give an increased range of adjustment on each brake rod a new adjustable clevis YE-2484 is now being used in place of the original design Y-2484. From Fig. 15 it will be seen that the new part is considerably longer than the original and gives approximately 1/2 inch more adjustment.

In order to make the brake rods of a suitable length for adjusting when the new clevis is used each rod has been reduced in length by approximately 1/2 inch,



although the part numbers have not been changed. Dealers may fit the new clevis to old brake rods, if required, by cutting 1/2 inch off the rod and running the thread down further to provide the increased clevis adjustment. The thread size is 1/4" x 28 NF2.

Events 2007

- 17/18 Feb. **Bristol Classic Car Show**
Shepton Mallet. Club stand.
Ivor Bryant 01454 411028
- 25 Feb. **Y&C committee meeting** Bob Wilkinson
Willoughby 01832 734463
- 22 April **Annual General Meeting** Bob Wilkinson
Willoughby Village Hall 01832 734463
- 22 April **National 'Drive it Day'.**
- 23/24 June **75th 'Y' anniversary gathering** Bob Wilkinson
Stanford Hall, Warwickshire 01832 734463
- 19 August **Powerscourt Picnic Run, Co. Dublin**
Irish Veteran & Vintage Car Club
John Fitzgerald
john.fitzgerald@electrolux.be

Members' cars

We have already seen both of Jim Miles's Eifels; his Fordor saloon and, recently, his new purchase, from the den Hartogh Museum in Holland; a 1937 Eifel roadster. Both Jim's Eifels are the later models with the alligator-V bonnet.

The subject of this issue's 'Members' Cars' is an earlier Model 'C' bonnet type of Eifel. This is an Eifel cabrio-limousine. We have two on the list of known surviving vehicles, both in Denmark. The subject one is owned by member, Michael Deichmann, who lives in a town

It is thought that the car was almost totally built in Köln (Cologne) and assembled in the Ford plant in Copenhagen, with some of the interior and glass provided on the Danish economy. The Ford Copenhagen oval disk is present on the bulkhead above the tool box. With a chassis number of C68864, the date of manufacture would have been at the tail end of 1936, which fits in quite nicely with the first known date of registration – 23rd February 1937.



The Ford Copenhagen copper oval plaque, which is riveted to the bulkhead above the toolbox and which reads only 'Ford Motor Company', with blanks labelled 'Type' and 'No.' and on which, in this case, is hand-stamped C and 68864 respectively.

called Vejby. Michael bought it in 1971 from Børge Kaa who, incidentally, has since bought another identically designed car – the second on the register.

Michael explains:- "The earliest owner I know of is Viklit Grå Jørgensen (Viklit Graa Joergensen), a long time veteran car enthusiast in Denmark. It was later owned by Frau Grete Simonsen of Hellerup (1958) and Børge Kaa (a member of the Y&C Register I think and owner now of a car exactly like mine). I bought it in 1971 from Børge Kaa and have had it since (I am probably the owner that has had it the longest time).

Neither Viklit or Børge had it registered. I registered it a few days after my 18th birthday (when I got my driver's License) on February 25th 1973 (unfortunately, not on the 23rd, which would have been exactly 36 years after its first registration). So this was my first car! The registration number was CU 36 715 with enamel licence plates.

For one or two years, I did not register the car and then re-registered it for its third and, so far, last period of registration with the number EH 50 914 - now with the new and current aluminium license plates. The picture with the Model 'Y' is taken at the Student Residence "Paul Bergsøe Kollegiet", north of Copenhagen, where for two years I was a student at the Technical University of Denmark. That basically "killed" the car. It was never too sound in the frame (chassis) and these 2 years made it virtually break. So it was unregistered and put in storage.

Restoration started at least 18 - 20 years ago (!!!) when the body was taken off the frame and the frame rebuilt. The middle section, which was virtually gone or nothing but iron oxide (or rust), has now been



Michael as an engineering student at university in about 1976, during the time when he was 'killing' the car. The Model 'Y' alongside is thought to still exist in the ownership of veteran car friend, Jems Hendrup, whom Michael is attempting to contact.

reconstructed. The frame is now galvanised and painted with black 2-component enamel (it should last my lifetime and beyond) and the whole front axle assembly is mounted with brakes and all. I am missing 2 bushes for the rear axle to so that I can put the refurbished rear suspension back.

The body is basically in good condition. The rear fenders were completely rebuilt by a metalsmith who had been educated in bodywork the old way - with 1mm iron-plate and acetylene gas. Together with the front fenders, they have been sandblasted and galvanised - not by dipping, but blasted on (I do not know the English word for that process). This gives a very good foundation for painting. The torpedo is also almost completed and could be mounted on the frame. [I have established that the 'torpedo' is the name given to the bulkhead and scuttle - Ed]

What needs to be done now is the rear wheel inner fenders and the valance at the back, below the spare wheel. A major issue is the panels under the doors. They have to be completely rebuilt. I have "specimens" of the old ones, and fortunately also Børge Kaa's Model 'C' cabrio-limousine to act as a pattern. [If you are referring to the sills, the Morris 1100 sills are very similar and can be easily adapted - Ed]

The wooden parts over the doors are in fairly good condition, but may need some work. The roof cloth needs to be replaced, but I have the one I had made in 1973, which may be used as model. The wood and metal parts are in OK condition.

The car did not have its original engine, so that must have been replaced at some point. I have obtained the correct type, but I do not know the condition of that. I have managed to get all copper/asbestos gaskets (head and manifold in particular). I expect to get this engine completely overhauled, but may choose to use one of the newer engine for this season (it could be a challenge to find a workshop these days that can do this, but the Club may be able to help. These days I do not see it as a problem to have these things done in the UK - the world has just

become smaller than 10 years ago, when I was a member last [see Tim Brandon under 'Useful Contacts' in the centre pages, Michael.] I have had the gearbox completely redone, with new bearings and a new syncromesh."

We wish Michael continued success with his restoration. 20 years is a fleeting moment in the great scheme of things! It is interesting to note that neither Michael's nor Børge's cars have the four chrome strips along the vertical bonnet louvres. Is this sheer coincidence or did Ford Copenhagen not fit them? The holes for the bifurcated holding pins are clearly visible in closer photographs, but they would have been stamped at the point of manufacture, before shipping to Copenhagen.

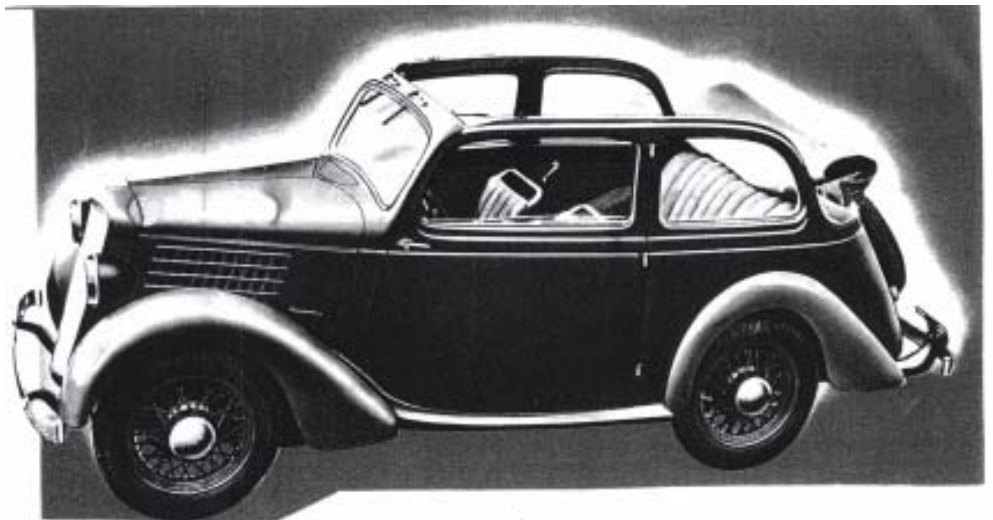

A promotional photograph of the 1935-36 cabrio-limousine showing the interior. Note the four chromed strips along the vertical bonnet louvres.

Photograph on back cover
Michael Deichmann's Ford Junior De Luxe cabrio-limousine shortly after Michael had it registered CU 36 715 in Denmark in 1973. The setting for this photograph is the Danish village of Bornholm. This car is the subject of Members' Cars in this issue.

